

Product technical sheet

FITNESS 1145



14+



< 140 kg



12,2 m2

Product data

Length	85 cm
Width	67 cm
Total height	174 cm
Age group	14+ years
Maximum weight of user	140 kg
Safety zone	12,2 m2
Free fall height	<60 cm
Weight of the heaviest part	18 kg
Dimensions of the largest part	41x19x141 cm
Availability of spare parts	YES
Installation time	1 h
Color options	

Data is subject to change without prior notice.

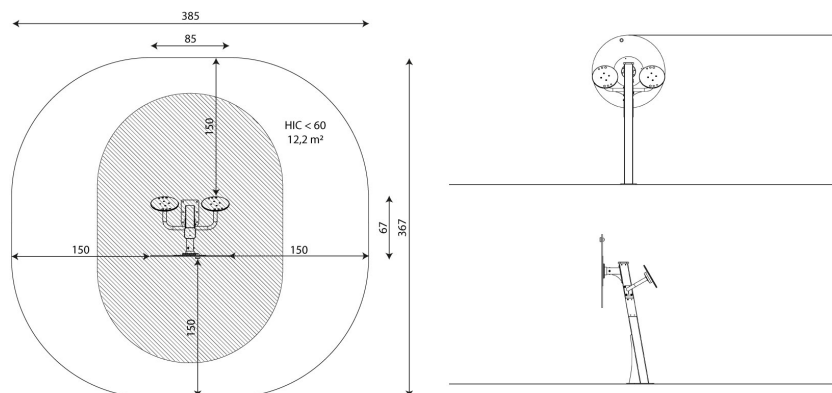

vinci
play

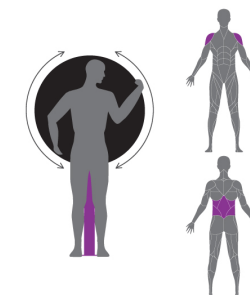
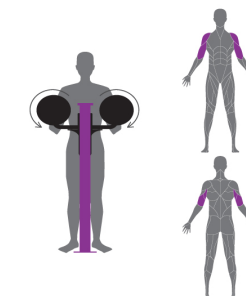

Vinci Group Sp. z o.o.
Seminaryjna 9 Street
99-400 Łowicz

VAT: 534-250-14-46
PHONE: +48 42 203 24 99 ext. 26
M: +48 793 404 991

22/07/2022

fitness

biuro@vinci-play.com
info@vinci-play.com
www.vinci-play.com

1 / 3

Material specification



Powder galvanized and powder coated or stainless steel construction of 100 x 100 mm profile,



Polycarbonate exercise instructions information plate and phone holder made of durable HDPE plate, resistant to weather conditions,



Rotary elements made of polycarbonate,



Powder galvanized and powder coated steel or stainless steel bars,



Moving elements based on bearings mechanism closed in casing, which do not require periodic greasing and maintenance, ensuring long service life of the device,

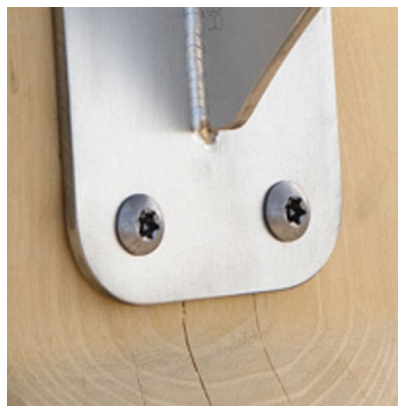

Stainless steel screws and/or screws covered with plastic caps,

Additional information

- equipment adapted for the disabled; device intended for public outdoor gyms;
- equipment has a certificate issued by an accredited entity or a declaration of conformity;
- no sharp edges or chinks that would pose a danger of jimmieing the head, fingers or any other body parts;
- anchoring on flat surface, 80/70 cm deep;
- render is for reference only, the actual appearance of the equipment and its color may vary;

Guarantee

- 30** 30 year guarantee - Structural strength of steel and stainless steel components
- 15** 15 year guarantee - Structural failure of steel and stainless steel, for dynamic equipment
- 10** 10 year guarantee - Structural failure of high density polyethylene and high pressure laminates components
- 5** 5 year guarantee - Corrosion of stainless steel and hot dip galvanized and powder coated components; against bark beetles and rot in case of wooden structural elements

Detailed information in the guarantee card

Vinci Group Sp. z o.o.
Seminaryjna 9 Street
99-400 Łowicz

VAT: 534-250-14-46
PHONE: +48 42 203 24 99 ext. 26
M: +48 793 404 991

22/07/2022

fitness

biuro@vinci-play.com
info@vinci-play.com
www.vinci-play.com

2 / 3

Amount of safe surface corresponding with free fall height:

HIC <60 12,2 m²

Data is subject to change without prior notice.

Surfaces according to EN

	Description (mm)	Layer thickness (cm)	Maximum fall height (cm)
Concrete / stone / bituminous surfaces (A, B, C)	-	-	≤100
outer soil layer (A,B,C)	-	-	≤120
Turf (A,B,C)	-	-	≤150
bark (A,C)	Particle size from 20 to 80	30	≤200
		40	≤300
wood shavings/cuttings (A, C)	Particle size from 5 to 30	30	≤200
		40	≤300
sand (A,C)	Particle size from 0,2 to 2 mm	30	≤200
		40	≤300
gravel (A,C)	Particle size from 2 to 8	30	≤200
		40	≤300
attested synthetic (A, B, C)	Tested according to EN 1177		60



Vinci Group Sp. z o.o.
Seminaryjna 9 Street
99-400 Łowicz

VAT: 534-250-14-46
PHONE: +48 42 203 24 99 ext. 26
M: +48 793 404 991

fitness

biuro@vinci-play.com
info@vinci-play.com
www.vinci-play.com