

Performer

PCE105721



The Performer is a fantastic, slick play unit that will motivate social play again and again. The different activities support children's play and encourage richer play times. Children can climb and slide, along with friends, which supports social relationships and emotional understanding. After climbing up the smooth steps of the inclined climbing wall, using cross-

coordination and strength to get to the platform, the double slide is a rewarding way to return to the ground, alone or with a friend. This helps children to continue the play on every level. They will find the Performer a great meeting place for play, with all the variation within a small space. The Fireman's pole adds a thrill for more courageous children. It additionally

trains spatial awareness and adds a feeling of achievement when children dare to use it. This variety motivates play hugely.

Item no. PCE105721-0903

General Product Information

Dimensions LxWxH	345x161x193 cm
Age group	2+
Play capacity (users)	6
Colour options	

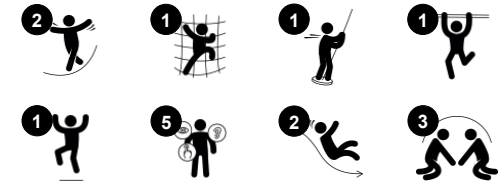

Performer

PCE105721



Platform

Social-emotional: the platform allows for more children to be together and share. Important life skills like courage, self-confidence, consideration and turn-taking are built.



Fireman's pole

Physical: coordination is supported when going down, as well as arm and core muscles. Landing strengthens bone density, which is built for life in early childhood.

Social-emotional: turn-taking and risk-taking.

Cognitive: young children develop their understanding of space, speed and distances when gliding down fast.



Double slide

Physical: sliding develops spatial awareness and a sense of balance. Furthermore, the core muscles are trained when sitting upright going down.

Social-emotional: invites socializing, supports parent-child and peer-to-peer play.

Cognitive: young children train their understanding of space, speed and distances when sliding down quickly.



Rock climber

Physical: supports cross coordination and leg, arm and hand strength.

Social-emotional: the inclination makes climbing feel secure, especially for younger children.



Performer

PCE105721



Panels of 19mm EcoCore™. EcoCore™ is a highly durable, eco friendly material, which is not only recyclable after use, but also consists of a core produced from 100% recycled post consumer material from food packing waste.



The ELEMENTS roofs are made of recyclable PE with a minimum wall thickness of 5 mm to ensure high durability in all climates around the world. The steel pipes are hot dip galvanised inside and outside for maximum durability.



Sails of commercial 95 high density PE knitted specially for sun-shade structures. The sails are treated with UV stabilizers to ensure a long life-time. The sails are supported by a hot dip galvanised steel frame and tightened by stainless steel devices.

Item no. PCE105721-0903

Installation Information

Max. fall height	100 cm
Safety surfacing area	22.5 m ²
Number of installers	2
Total installation time	7.8
Excavation volume	1.06 m ³
Concrete volume	0.34 m ³
Footing depth (standard)	90 cm
Shipment weight	231 kg
Anchoring options	In-ground ✓ Surface ✓

Warranty Information

EcoCore HDPE	Lifetime
Post	10 years
PP Decks	10 years
Hollow PE parts	10 years
Spare parts guaranteed	10 years



The main posts are made of high quality pre-galvanized steel with powder coated top finish. Post tops are closed with caps of UV stabilized nylon (PA6). The grey colored molded decks are made of 75% post-consumer ocean waste PP material with a non-skid pattern and texture surface. All decks are supported by unique designed low-carbon aluminum profiles with multiple attachment options.

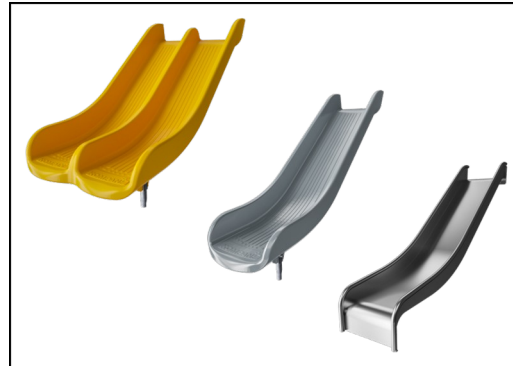

The slides are available in either moulded PE in different colours or in full stainless steel AISI304 t= 2mm.

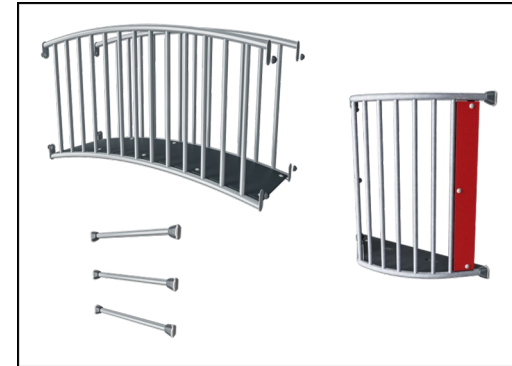

The steel surfaces are hot dip galvanised inside and outside with lead free zinc. The galvanisation has excellent corrosion resistance in outside environments and requires low maintenance.





Cradle to Gate A1-A3	Total CO ₂ emission	CO ₂ e/kg	Recycled materials
	kg CO ₂ e	kg CO ₂ e/kg	%
PCE105721-0903	481.20	2.65	41.10

The overall framework applied for these factors is the Environmental Product Declaration (EPD), which quantifies "environmental information on the life cycle of a product and enable comparisons between products fulfilling the same function" (ISO, 2006). This follows the structure and applies a Life-Cycle Assessment approach to the entire Product stage from raw material through manufacturing (A1-A3))

Kompan A/S
 C.F. Tietgens Boulevard 32C
 DK-5220 Odense SØ
 Denmark

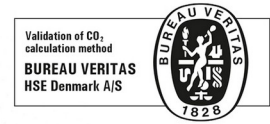

Validation of CO₂ calculation of: Play systems



Data version no. 2021-01-11

The CO₂ calculation and data are in compliance with the principles of a carbon footprint impact according to the GHG protocol (Greenhouse Gas Protocol), Scope 3, cradle to gate related to all individual components in the product category: "Play systems" represented by item no.: PCM200309-0010. (Scope 3 emissions include emission sources in the upstream and downstream value chain).

Date: 15. October 2021 | Valid until: 15. October 2023

Validated by:

Bente Hviid, Senior Consultant

Peter Bendtsen, Senior Consultant

Validation based on report: Validation of CO₂ calculation of play systems – Kompan, version 1.0, prepared by: Bureau Veritas HSE, Denmark: Bente Hviid and Peter Bendtsen.

Publication date: 15. October 2021

By Bureau Veritas HSE
 www.bureauveritas.dk
 +45 7731 1000



Performer

PCE105721

* Max fall height | ** Total height | *** Safety surfacing area

* Max fall height | ** Total height

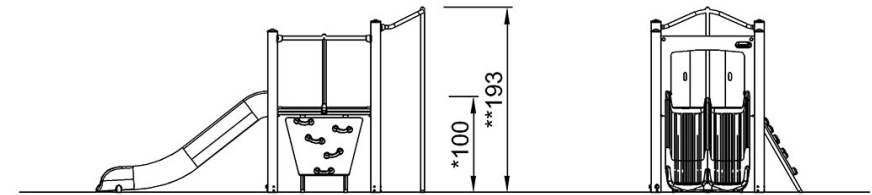
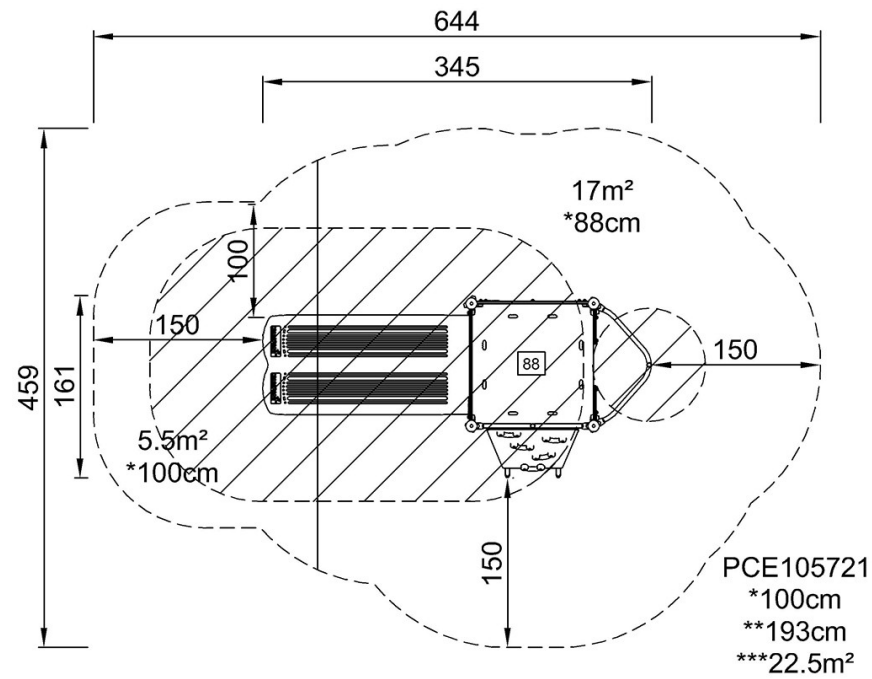

PCE105721

[Click to see TOP VIEW](#)

[Click to see SIDE VIEW](#)