



Charleston

Hula

Twist







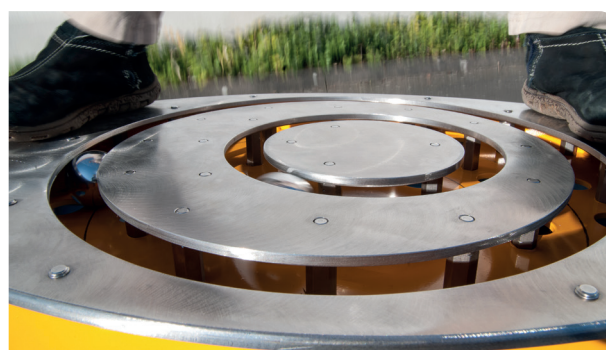

## Tanzschule

### Dancer

Balancieren und seine Geschicklichkeit beweisen; diese Herausforderungen kann man auf der Tanzschule mit einem Hüftschwung meistern.

Balancing and showing your skillfulness – on the Dancer these challenges can be mastered with a swing of your hips.



-  **Ab 3 Jahren**  
3 years plus
-  **Beton C 20/25 L x B x H: 500 x 500 x 600 mm**  
concrete C20/25 L x W x H: 500 x 500 x 600 mm  
3.500 psi please refer to your local dealer
-  **ø x H: 3.700 x 3.000 mm**  
ø x H: 3.700 x 3.000 mm
-  **In Deutschland nicht erforderlich**  
necessary
-  **Für losen Fallschutz nicht geeignet**  
not suitable for loose fill safety surfacing
-  **L x B x H: 615 x 405 x 335 mm**  
L x W x H: 615 x 405 x 335 mm
-  **450 mm**  
450 mm
-  **Edelstahl, lackierter Edelstahl**  
stainless steel, lacquered stainless steel
-  **Charleston: rot, Twist: gelb, Hula: blau**  
Charleston: red, Twist: yellow, Hula: blue
-  **45 kg, L x B x H 0,75 x 0,75 x 0,65 m**  
53 kg, L x W x H 0,75 x 0,70 x 0,70 m



# Tanzschule

## Dancer

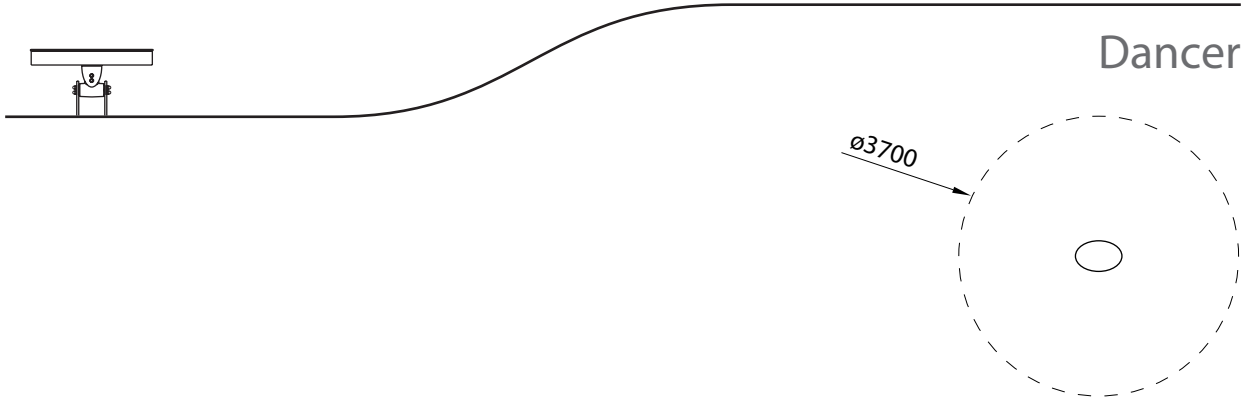

Charleston

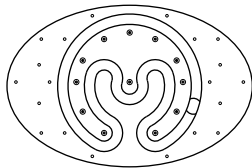

Hula

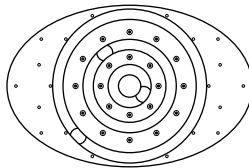

Twist

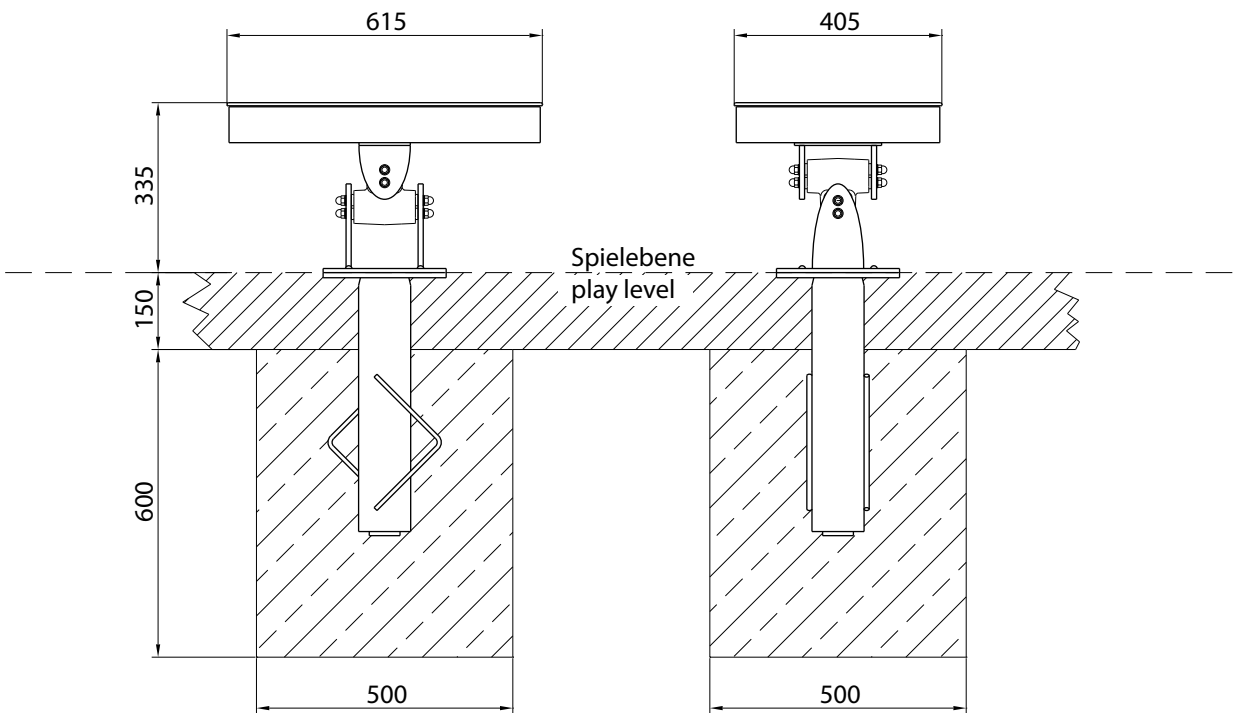
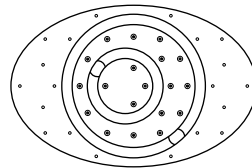

Achtung! Für Einbau aktuelle Montageanleitung anfordern.

Technische Änderungen vorbehalten. Stand: 06.2018

