

OBSTACLES CANINE

ref. BCMC001

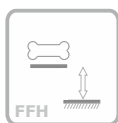

www.bragmaia.com

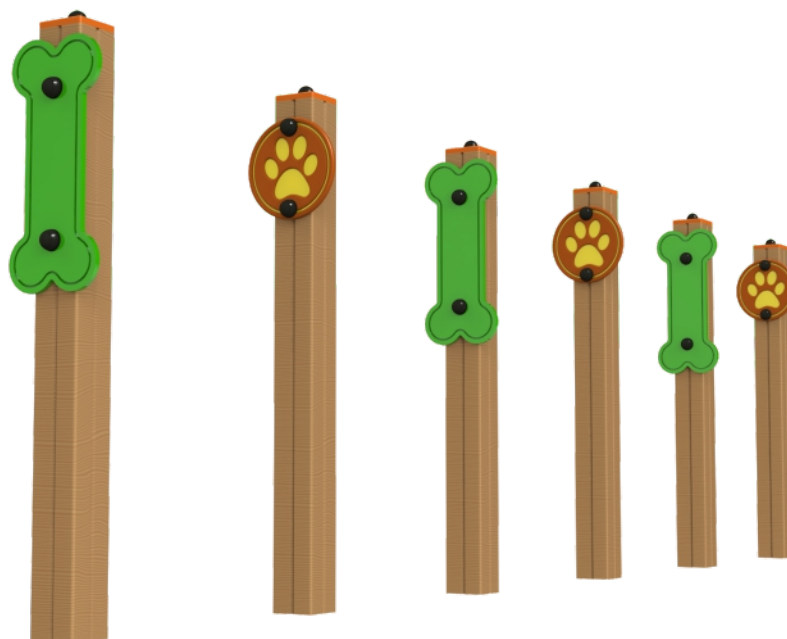

1.00 m

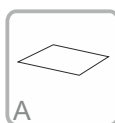

16 m²

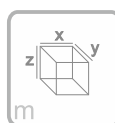

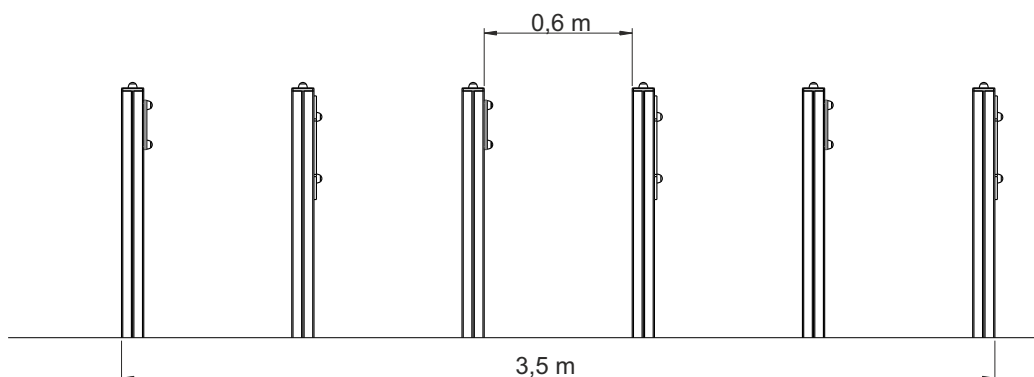
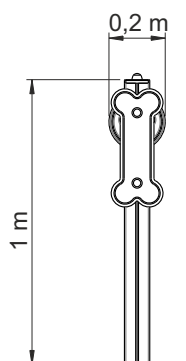

x= 0.20
y= 3.50
z= 1.00



Equipment Information:



.....	①
	1,00
	21

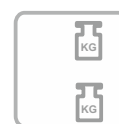
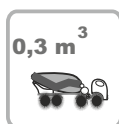
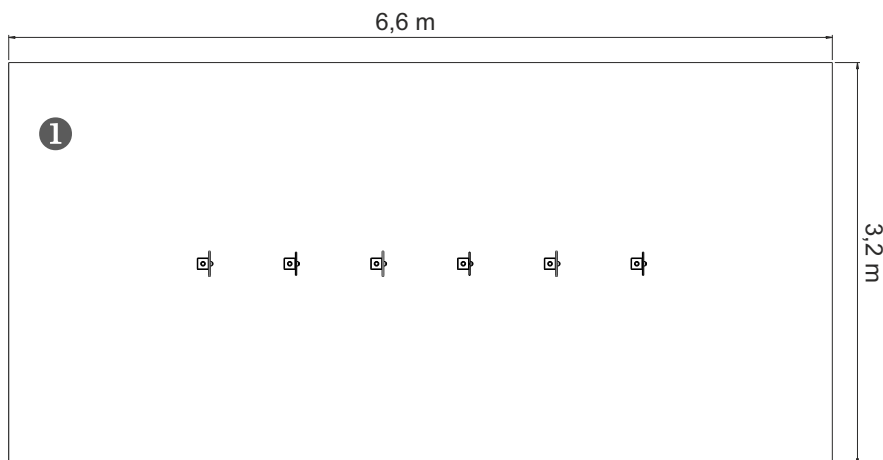

Technical Information:

1 - Obstacles  1.00m

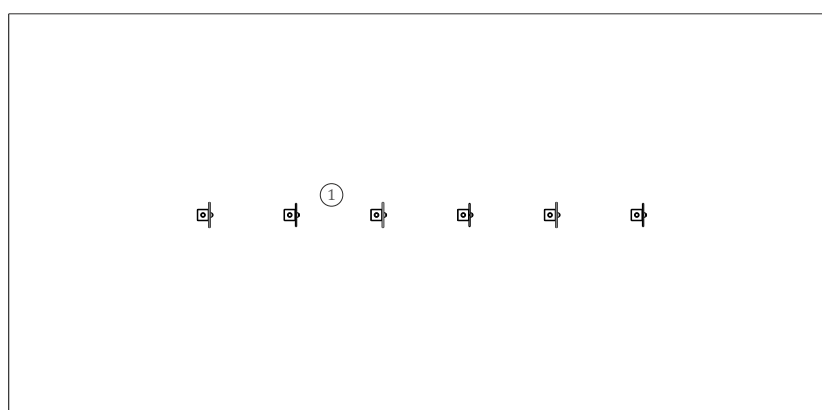







Technical Characteristics:



Vertical post

Wood: Laminated pinewood classified with guarantee of quality by continuous internal control. With autoclave treatment, protecting it from attacks of fungus, insects and termites. Finishing on aqueous base ink, specially developed to protect the wood from humidity, weather and U.V.

**PROTECT DECORATES:**

 <small>Penetrates into the wood grain highlighting and beautifying the wood with its transparent special colors</small>	 <small>Very resistant to sun. Contains micronized absorbing pigments and U.V. stabilizers</small>	 <small>Microporous, lets the wood breathe and prevents the natural deformation of wood</small>	 <small>Easy maintenance. No sanding or stripping is necessary for the application of the new layers</small>	 <small>ACTIVE INGREDIENTS Giving a protective barrier against fungus and mold</small>	 <small>HYDROFUGE Protects against moisture, rain and waterproofs</small>
--	--	---	---	--	---

Panel

HDPE: Monocolour/bicolour high density polyethylene. It is a polymer so it is characterized by its resistance to corrosion and chemical products. By its capacity of elasticity and lightweight, it offers high resistance to impacts, and, therefore, very difficult to break. The synthetic base prevents growth of bacteria and fungus. No need for maintenance;

Fixation System:

Type C - Standard fixation system composed by posts applied directly in the ground with concrete;

Screws and accessories

Screws: Galvanized steel or optionally stainless steel AISI 304;

Capsules: PP Polypropylene plastic;



100% recyclable;

