

Bridge

ref. EDCB008



www.bragmaia.com



+8 Years

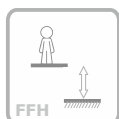

0.60 m

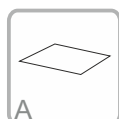

28.4 m²

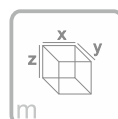

**x= 4.10
y= 1.00
z= 0.60**

Data Sheet

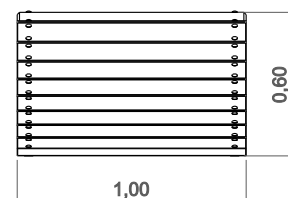
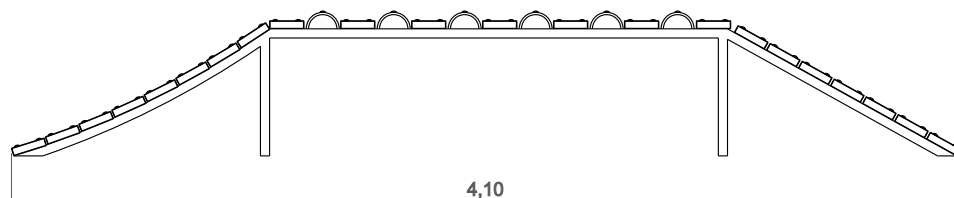

Equipment Information:

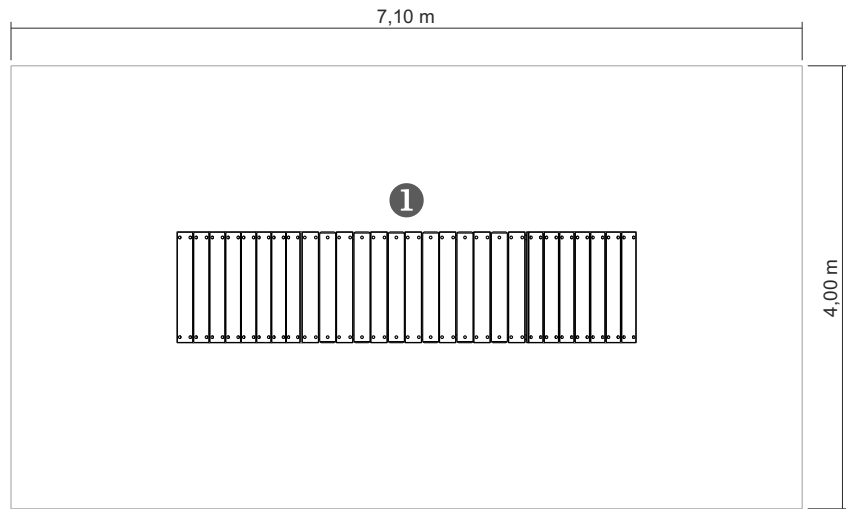

— Impact area
 - - Free space
 EN 1176-1,3

.....	①
0,60	
28,4	
28,4	

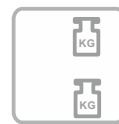
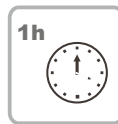

Technical Information:

1 - Bridge 0.60m

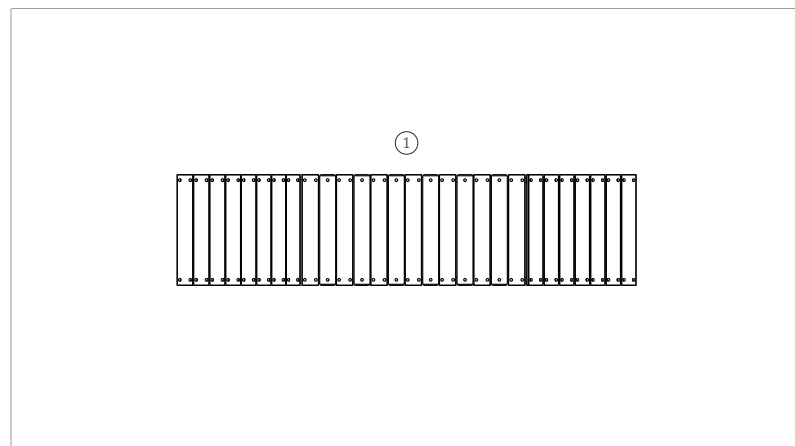







Technical Characteristics:



The Surface

Wood: Laminated pinewood classified with guarantee of quality by continuous internal control. With autoclave treatment, protecting it from attacks of fungus, insects and termites. Finishing on aqueous base ink, specially developed to protect the wood from humidity, weather and U.V.

 **PROTECT DECORATES:**

 <small>Penetrates into the wood grain highlighting and beautifying the wood with its transparent special colors</small>	 <small>Very resistant to sun. Contains micronized absorbing pigments and U.V. stabilizers</small>	 <small>Microporous, lets the wood breathe and prevents the natural deformation of wood</small>	 <small>Easy maintenance. No sanding or stripping is necessary for the application of the new layers</small>	 <small>ACTIVE INGREDIENTS Giving a protective barrier against fungus and mold</small>	 <small>HYDROFUGE Protects against moisture, rain and waterproofs</small>
--------------------------------------------------------------------------------------------------------------------------------------------------------------------------------------------------------------	----------------------------------------------------------------------------------------------------------------------------------------------------------------------------------------	-------------------------------------------------------------------------------------------------------------------------------------------------------------------------------------	---------------------------------------------------------------------------------------------------------------------------------------------------------------------------------------------------	----------------------------------------------------------------------------------------------------------------------------------------------------------------------------------	---------------------------------------------------------------------------------------------------------------------------------------------------------------------

Metal parts

Structure:

Iron: Anticorrosive treatment of hot dip galvanizing in accordance with EN ISO 1461;

Fixation System:

Type C - Standard fixation system composed by posts applied directly in the ground with concrete;

Screws and accessories

Screws: Galvanized steel or optionally stainless steel AISI 304;



100% recyclable;

