

Fun Box I

ref. EDPR040

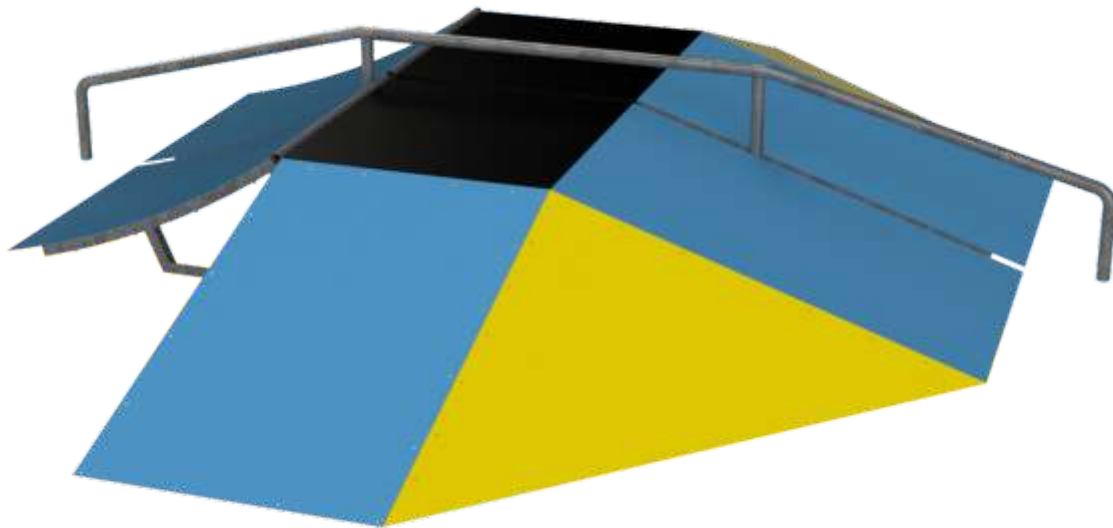

www.bragmaia.com



+8 ANOS

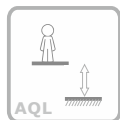

0 m

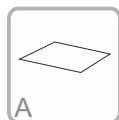

210 m²

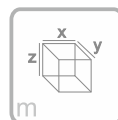

**x= 5.10
y= 6.10
z= 0.60**

Ficha Técnica

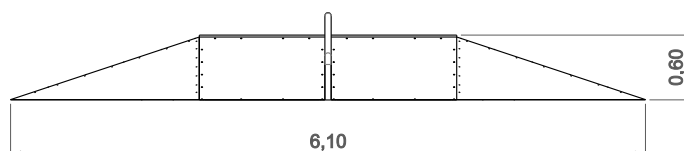
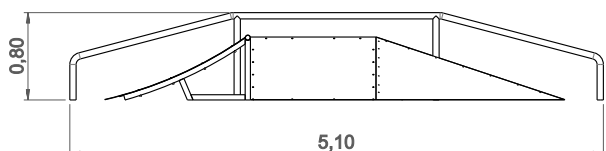

Informação do Equipamento:



— Zona de impacto
 - - Espaço livre
 EN 1176-1,3

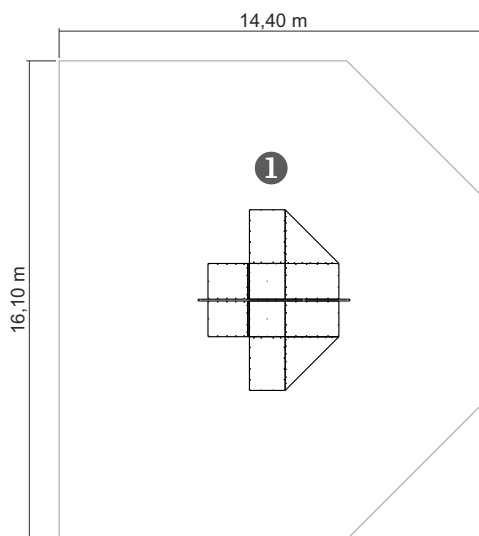

.....	①
	0
	210
	210

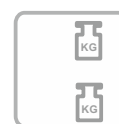
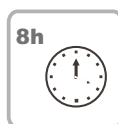
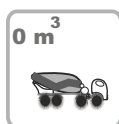

Informação Técnica:

1 - Fun Box I

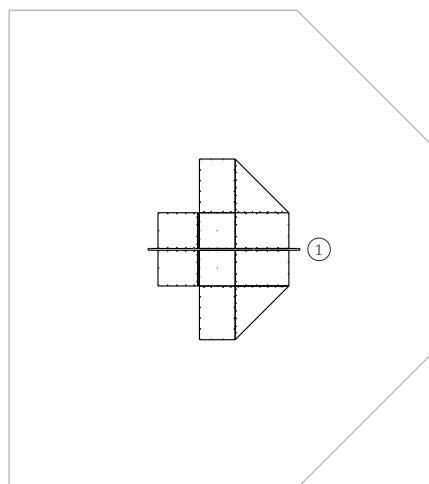

Características Técnicas:



Tabuleiro

Contraplacado marítimo: antiderrapante, colado com resinas fenólicas resistentes as intempéries e raios UV. em conformidade com as normas EL 314-2/classe 3 (DIN 68 TS TCIL3: BFU 100, BS 6566 PART 8 : WBP);

Peças Metálicas

Estrutura e Carril: Ferro com tratamento anticorrosivo de galvanização por imersão a quente de acordo com a norma EN ISO 1461;

Superfície: Chapa de ferro eletrozincada e lacada a esmalte tipo gel a 230°C, com espessura entre 50 a 70µm, de acordo com a norma UNE EN ISO 2808;

Sistema de fixação:

Tipo B - Sistema de fixação standard composto por base metálica aparafusada ao solo com buchas metálicas;

Parafusos e acessórios

Parafusos: Aço zincado ou opcionalmente aço inox AISI 304;



100% reciclável;

