

Boleto 2

ref. ELBOL001 P

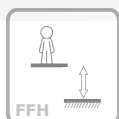

3-14 Years



0.80 m

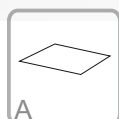

21 m²

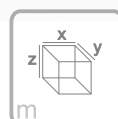

x= 3.10
y= 0.30
z= 0.80

Data Sheet

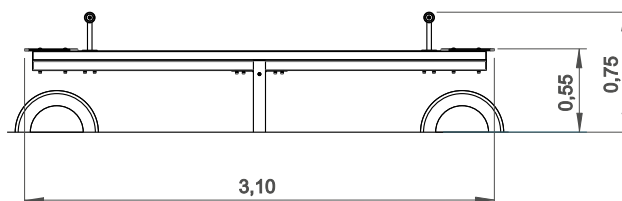
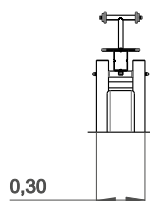



Equipment Information:

— Impact area
 - - Free space

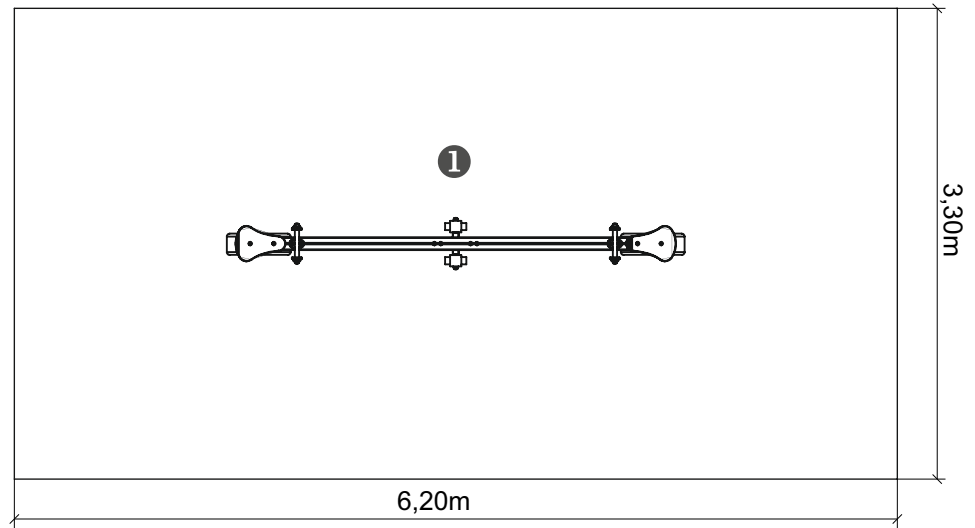
EN 1176-1,6





.....	①
	0,80
	21
	21

0,06 m³



3h



2x



15 KG



40 KG



Technical Information:

1 - Seat  0.80m

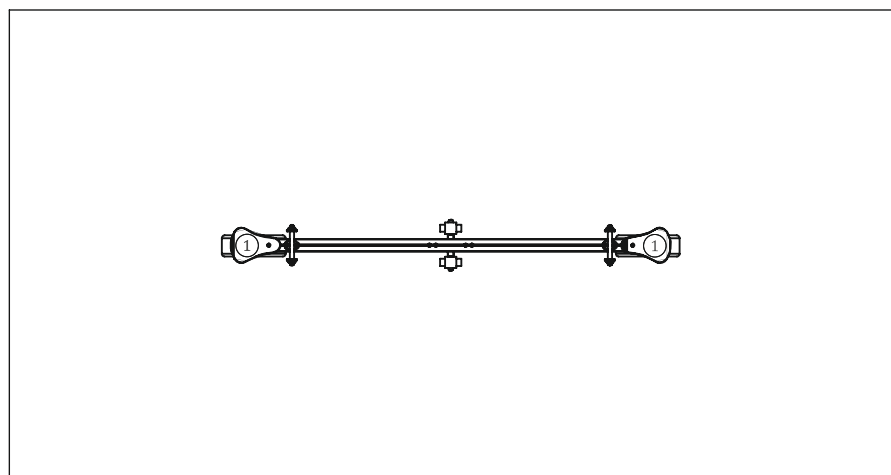









bragmaia®

Technical Characteristics:

Beam

Wood: Laminated pinewood classified with guarantee of quality by continuous internal control. With autoclave treatment, protecting it from attacks of fungus, insects and termites. Finishing on aqueous base ink, specially developed to protect the wood from humidity, weather and U.V.

 **PROTECT DECORATES:**

					
Penetrates into the wood grain highlighting and beautifying the wood with its transparent special colors	Very resistant to sun. Contains micronized absorbing pigments and U.V. stabilizers	Microporous. lets the wood breathe and prevents the natural deformation of wood	Easy maintenance. No sanding or stripping is necessary for the application of the new layers	Giving a protective barrier against fungus and mold	Protects against moisture, rain and waterproofs

Panels

HDPE: Monocolour/bicolour high density polyethylene. It is a polymer so it is characterized by its resistance to corrosion and chemical products. By its capacity of elasticity and lightweight, it offers high resistance to impacts, and, therefore, very difficult to break. The non-slip surface offers security to children and the synthetic base prevents grow of bacterias and fungus. No need for maintenance;

Metal parts

Tubes:

Stainless steel: AISI 304, Ø30mm;

Iron: Anticorrosive treatment of hot dip galvanizing in accordance with EN ISO 1461. Gel type lacquer at 230 ° C with thickness ranging from 50 to 70µm, according to the UNE EN ISO 2808;

Fixation System:

Type A - Standard fixation system composed by steel base embedded in the ground with concrete;

Type B - Standard fixation system composed by steel base screwed to the ground with steel anchors;

Screws and accessories

Screws: Galvanized steel or optionally stainless steel AISI 304;

Capsules: PP Polypropylene plastic;



100% recyclable;

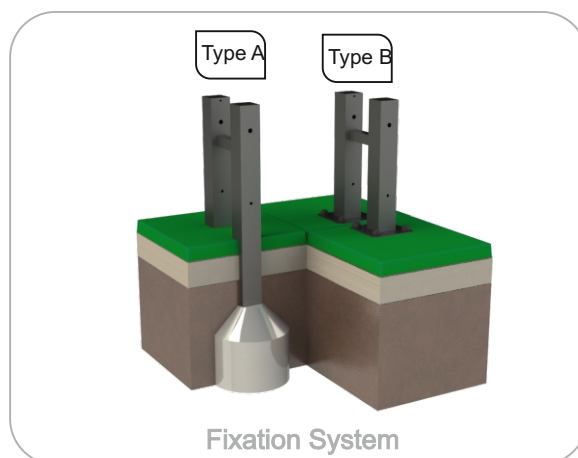

Playful Activities:



Amuse: While they have fun, children acquire several capacities, since physical abilities to social interactions.



Socialize: The socialization and imagination are necessary in all games. All of it creates a relation between children and arouses the sense of coexistence and solidarity.



Play: Develops both patience, sharing and sportsmanship.



Rocking: This action helps to develop the child balance and teaches him how to control the movements with the right balance and strength, which improves psychomotor activity and body coordination.