

# Locomotiva

ref. ELCMB001

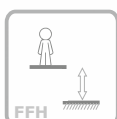

2-6 Years



0.50 m

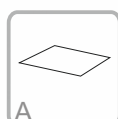

20 m<sup>2</sup>

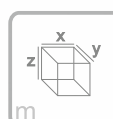

x= 1.05  
y= 2.40  
z= 1.40

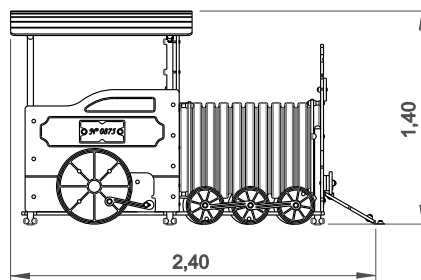
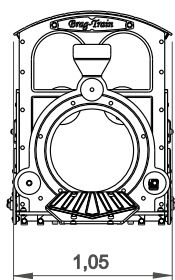



Data Sheet

# Equipment Information:

— Impact area  
 - - Free space

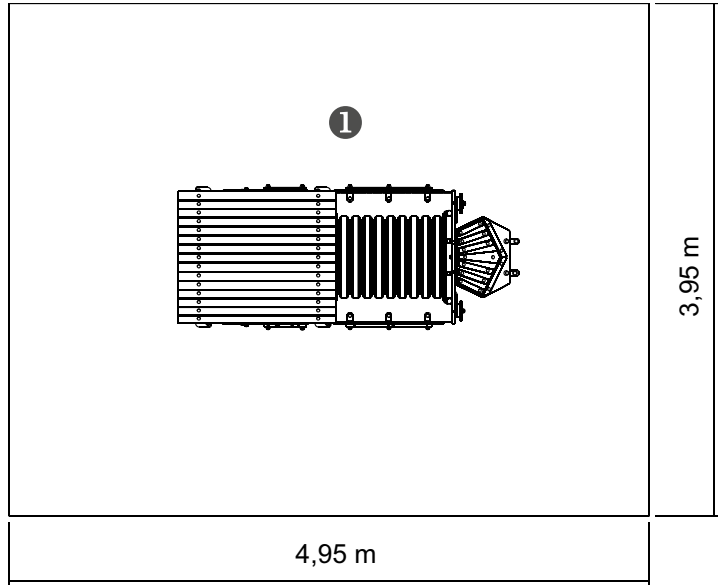
EN 1176-1 



.....	①
	0.50
	20
	20

0.48m<sup>3</sup>  



16h  

2x  

KG  

KG  

# Technical Information:

1 - Locomotive  0.50m

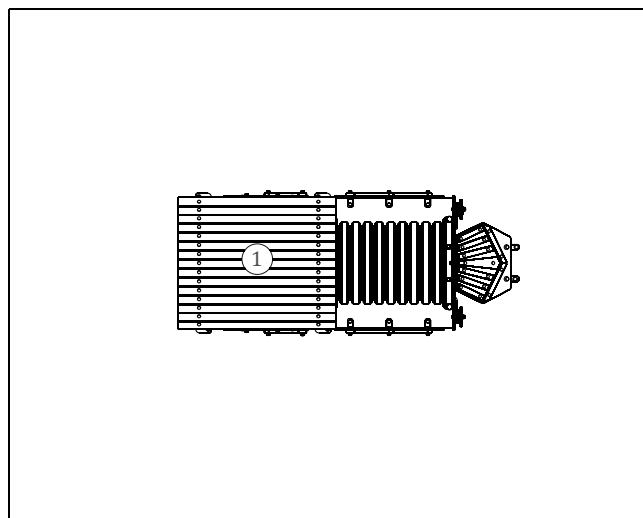

# Technical Characteristics:



**bragmaia**<sup>®</sup>

## Panels

**HDPE:** Monocolour/bicolour high density polyethylene. It is a polymer so it is characterized by its resistance to corrosion and chemical products. By its capacity of elasticity and lightweight, it offers high resistance to impacts, and, therefore, very difficult to break. The non-slip surface offers security to children and the synthetic base prevents grow of bacterias and fungus. No need for maintenance;

**Marine plywood:** Non-slip, bonded with phenolic resins resistant to the weather and U.V., according to EL 314-2/classe 3 (DIN 68 TS TCIL3: BFU 100, BS 6566 PART 8 : WBP);

## Plastic parts

**Tunnel:** Made of polypropylene corrugated tube in conformity with EN 13476;

## Metal parts

**Sliding surface:** Stainless steel plate AISI 304, bent and rolled from one piece;

## Tubes:

**Stainless steel:** AISI 304, Ø40mm;

## Fixation System:

**Type A - Standard fixation system** composed by steel base embedded in the ground with concrete;

**Type B - Standard fixation system** composed by steel base screwed to the ground with steel anchors;

## Screws and accessories

**Screws:** Galvanized steel or optionally stainless steel AISI 304;

**Capsules:** PP Polypropylene plastic;



100% recyclable;

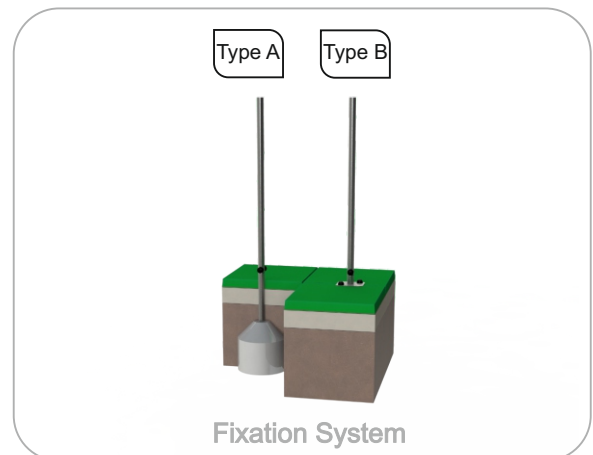

# Playful Activities:



**Amuse:** While they have fun, children acquire several capacities, since physical abilities to social interactions.



**Socialize:** The socialization and imagination are necessary in all games. All of it creates a relation between children and arouses the sense of coexistence and solidarity.



**Play:** Develops both patience, sharing and sportsmanship.



**Sliding:** A sloped surface allows the child to slide in great velocity, a sensation that makes him feel alive and learn to control his movements, reflexes and psychomotor abilities.