

Brag-Train

ref. ELCMB005

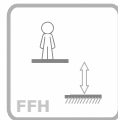

2-6 Years



1.10 m

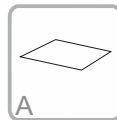

68 m²

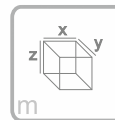

x= 13.10
y= 1.20
z= 1.80

Data Sheet

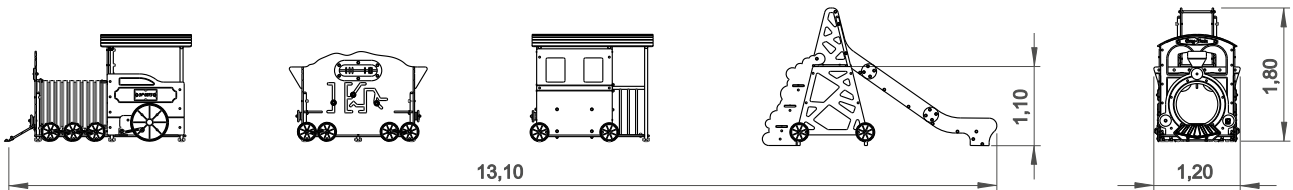

Equipment Information:

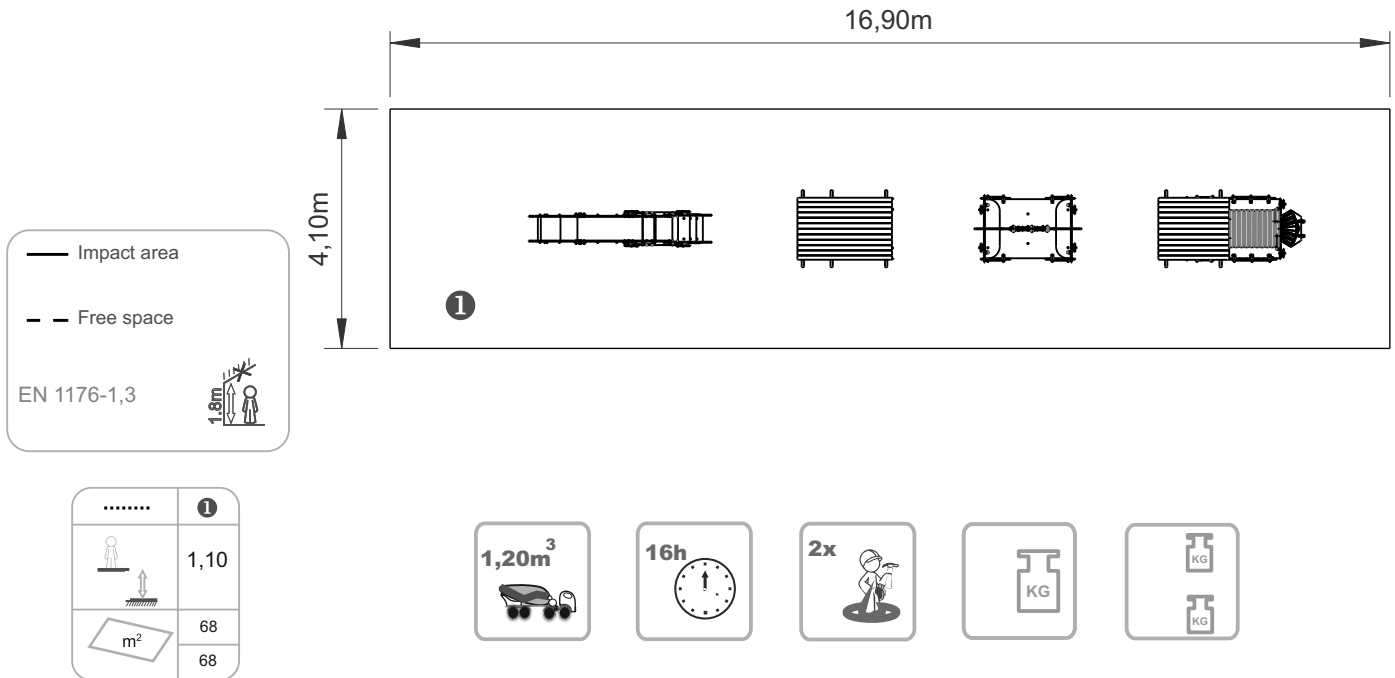

Technical Information:

- 1 - Locomotive 0.50m
- 2 - Playful Carriage 0.50m
- 3 - Carriage 0.50m
- 4 - Carriage Slide 1.10m

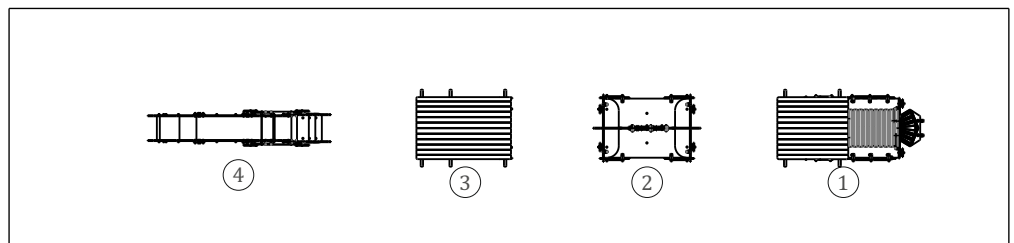

Technical Characteristics:

Panels

HDPE: Monocolour/bicolour high density polyethylene. It is a polymer so it is characterized by its resistance to corrosion and chemical products. By its capacity of elasticity and lightweight, it offers high resistance to impacts, and, therefore, very difficult to break. The non-slip surface offers security to children and the synthetic base prevents grow of bacterias and fungus. No need for maintenance;

Marine plywood: Non-slip, bonded with phenolic resins resistant to the weather and U.V., according to EL 314-2/classe 3 (DIN 68 TS TCIL3: BFU 100, BS 6566 PART 8 : WBP);

Plastic parts

Tunnel: Made of polypropylene corrugated tube in conformity with EN 13476;

Metal parts

Sliding surface: Stainless steel plate AISI 304, bent and rolled from one piece;

Tubes:

Stainless steel: AISI 304, Ø40mm;

Fixation System:

Type A - Standard fixation system composed by steel base embedded in the ground with concrete;

Type B - Standard fixation system composed by steel base screwed to the ground with steel anchors;

Screws and accessories

Screws: Galvanized steel or optionally stainless steel AISI 304;

Capsules: PP Polypropylene plastic;



100% recyclable;

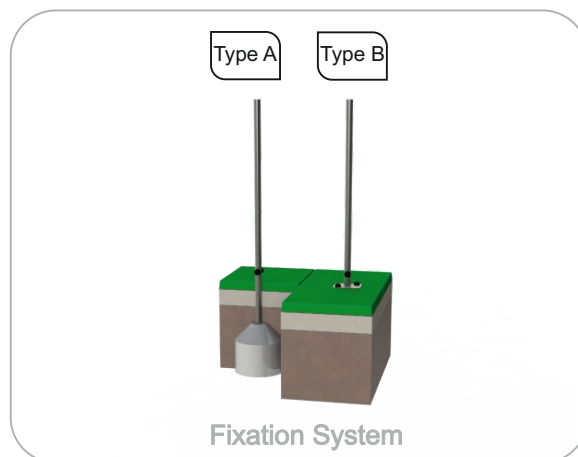

Playful Activities:



Amuse: While they have fun, children acquire several capacities, since physical abilities to social interactions.



Socialize: The socialization and imagination are necessary in all games. All of it creates a relation between children and arouses the sense of coexistence and solidarity.



Play: Develops both patience, sharing and sportsmanship.



Sliding: A sloped surface allows the child to slide in great velocity, a sensation that makes him feel alive and learn to control his movements, reflexes and psychomotor abilities.