

# Mikania 3

ref. ELDAN013AL

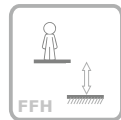

3-14 Years



1.35 m

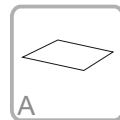

41 m<sup>2</sup>

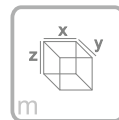



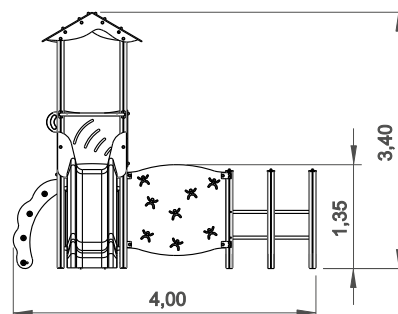
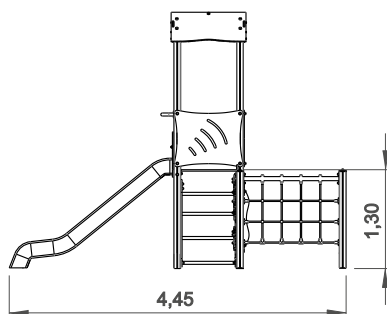

x= 4.45  
y= 4.00  
z= 3.40

Data Sheet

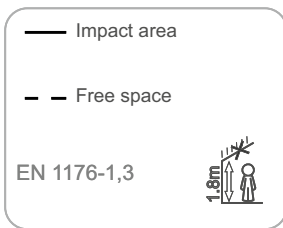





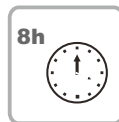
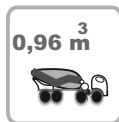
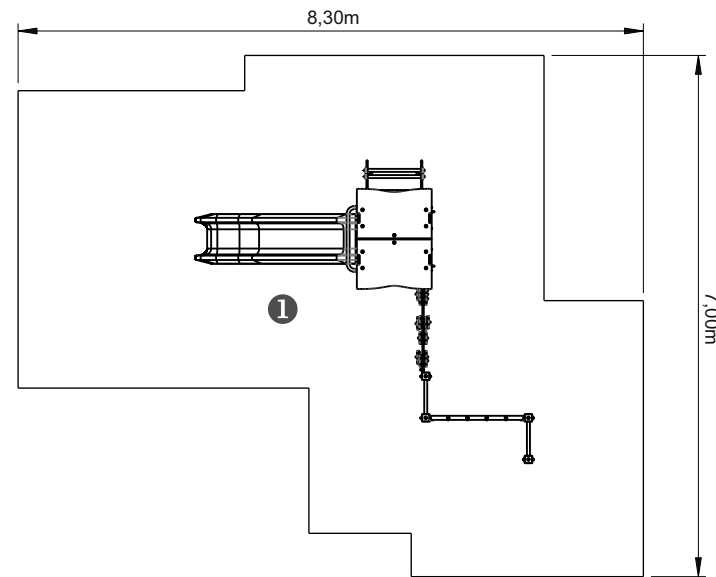

# Equipment Information:



.....	①
	1,35
	41
	41



# Technical Information:

- 1 - Cloud Tower  1.30m
- 2 - Simple Ladder 1,3m  1.30m
- 3 - Slide  1.30m
- 4 - Ladder 1,3m  0.80m
- 5 - Climbing Net 1,2m  1.20m
- 6 - Climbing 1,3m  1.35m
- 7 - Noughts and Crosses

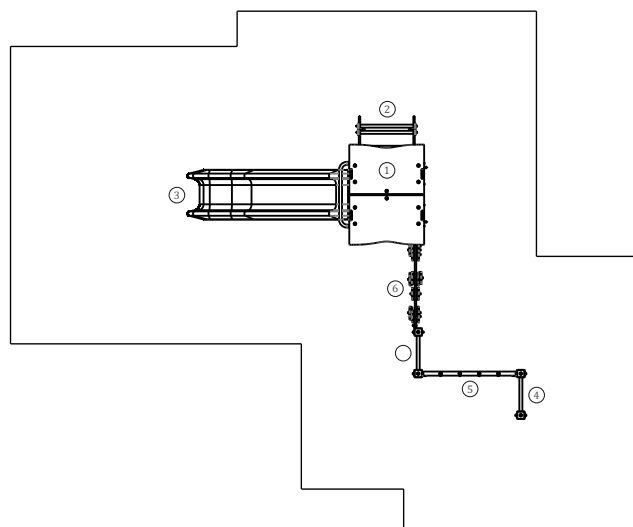



bragmaia®

# Technical Characteristics:

## Vertical posts

**Aluminum:** 90x90x2.5mm profile alloy 6063 and T66 treatment, which is an alloy extrusion excellence, exhibits excellent corrosion resistance with good surface finish. The T66 treatment in which this alloy is solubilized, tempered and artificially aged, aims to improve its mechanical properties. This is supplied at natural color with the option of being lacquered RAL according to customer needs;

## Panels

**HDPE:** Monocolour/bicolour high density polyethylene. It is a polymer so it is characterized by its resistance to corrosion and chemical products. By its capacity of elasticity and lightweight, it offers high resistance to impacts, and, therefore, very difficult to break. The non-slip surface offers security to children and the synthetic base prevents grow of bacterias and fungus. No need for maintenance;

**Net:** Ø16mm steel ropes coated in reinforced polypropylene fibers, connection accessories in HDPE with U.V. protection, fixing elements in galvanized hot steel;

**Marine plywood:** Non-slip, bonded with phenolic resins resistant to the weather and U.V., according to EL 314-2/classe 3 (DIN 68 TS TCIL3: BFU 100, BS 6566 PART 8 : WBP);

## Plastic parts

**Slide:** High density polyethylene, resistant to U.V., high resistance to rupture and high security;

## Metal parts

### Tubes:

**Stainless steel:** AISI 304, Ø40mm and Ø54mm;

### Fixation System:

**Type B - Standard fixation system** composed by steel base screwed to the ground with steel anchors;

**Type C - Standard fixation system** composed by posts applied directly in the ground with concrete;

## Screws and accessories

**Screws:** Galvanized steel or optionally stainless steel AISI 304;

**Capsules:** PP Polypropylene plastic;



100% recyclable;

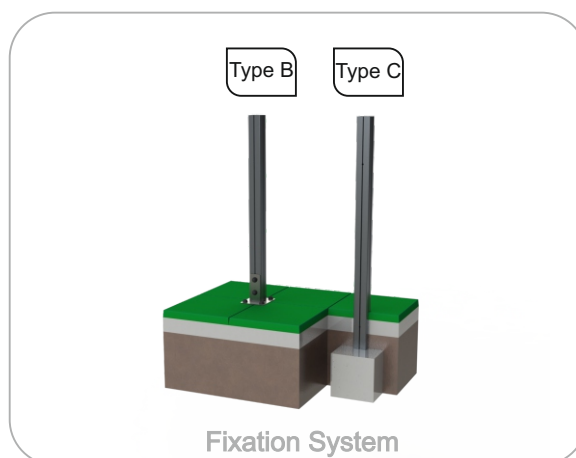

# Playful Activities:



**Amuse:** While they have fun, children acquire several capacities, since physical abilities to social interactions.



**Socialize:** The socialization and imagination are necessary in all games. All of it creates a relation between children and arouses the sense of coexistence and solidarity.



**Play:** Develops both patience, sharing and sportsmanship.



**Sliding:** A sloped surface allows the child to slide in great velocity, a sensation that makes him feel alive and learn to control his movements, reflexes and psychomotor abilities.



**Climbing:** A movement to develop children motor skills, body control, balance and coordination, which stimulates the motor capacity an own body security.