

Zea 2

ref. ELDAN029BAL

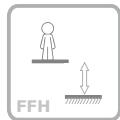

0.5-14 Years



1.40 m

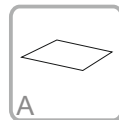

28 m²

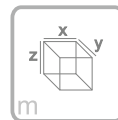

x= 3.30
y= 1.75
z= 2.40

Data Sheet

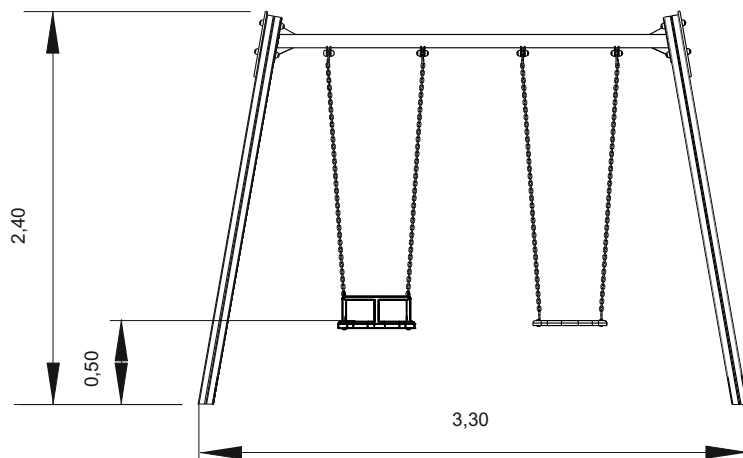
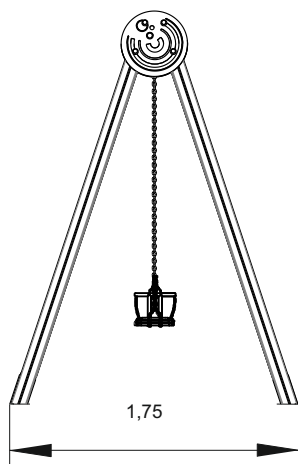



Equipment Information:

— Impact area
 - - Free space

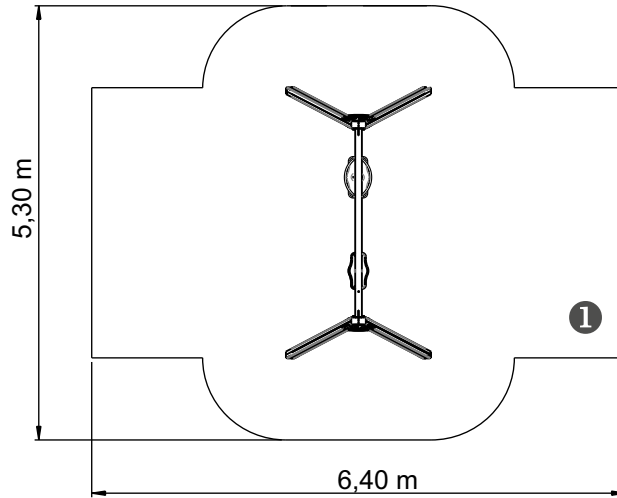

EN 1176-1,2



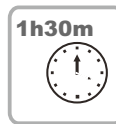
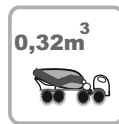

.....	①
	1,40
	28
	28

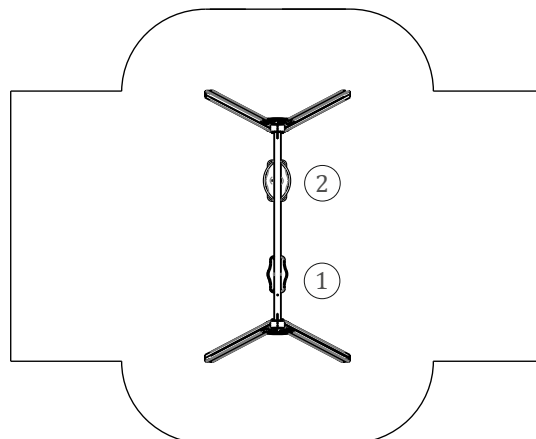

Technical Information:

- 1 - Seat  0.50m
- 2- Baby chair  0.50m



Technical Characteristics:

Vertical posts

Aluminum: 90x90x2.5mm profile alloy 6063 and T66 treatment, which is an alloy extrusion excellence, exhibits excellent corrosion resistance with good surface finish. The T66 treatment in which this alloy is solubilized, tempered and artificially aged, aims to improve its mechanical properties. This is supplied at natural color with the option of being lacquered RAL according to customer needs;

Panels

HDPE: Monocolour/bicolour high density polyethylene. It is a polymer so it is characterized by its resistance to corrosion and chemical products. By its capacity of elasticity and lightweight, it offers high resistance to impacts, and, therefore, very difficult to break. The non-slip surface offers security to children and the synthetic base prevents grow of bacterias and fungus. No need for maintenance;

Chairs and seats: Are made of EPDM rubber injected with aluminium reinforcement inside . Chains with Ø5mm in hot galvanized steel;

Metal parts

Tubes:

Iron: Anticorrosive treatment of hot dip galvanizing in accordance with EN ISO 1461;

Fixation System:

Type B - Standard fixation system composed by steel base screwed to the ground with steel anchors;

Type C - Standard fixation system composed by posts applied directly in the ground with concrete;

Screws and accessories

Screws: Galvanized steel or optionally stainless steel AISI 304;

Capsules: PP Polypropylene plastic;



100% recyclable;

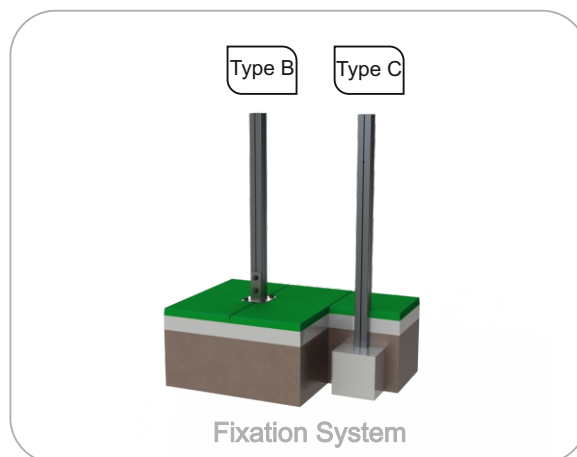

Playful Activities:



Amuse: While they have fun, children acquire several capacities, since physical abilities to social interactions.



Socialize: The socialization and imagination are necessary in all games. All of it creates a relation between children and arouses the sense of coexistence and solidarity.



Play: Develops both patience, sharing and sportsmanship.



Swinging: The nervous system is stimulated by this movement, mainly the psychomotor system and the sight. It is also relaxing and, in addition, it helps developing the balance and coordination faculties.