

Inga 2

ref. ELDAN043



3-14 YEARS



2.00 m

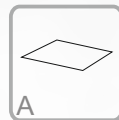

27 m²

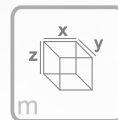

x= 2.30
y= 1.20
z= 2.10

Data Sheet

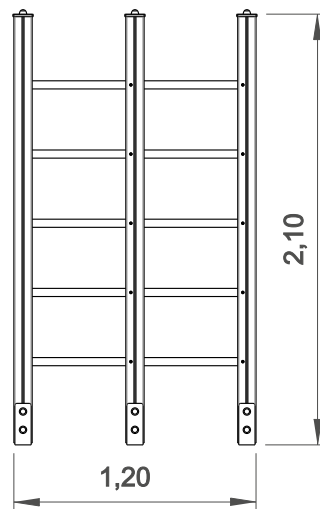
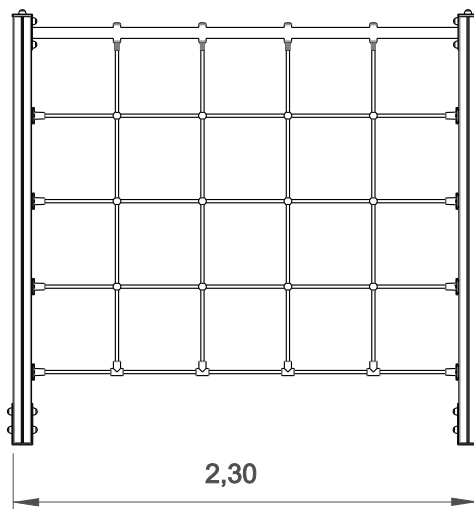

Equipment Information:



bragmaia®

— Impact area
 - - Free space

EN 1176-1,3

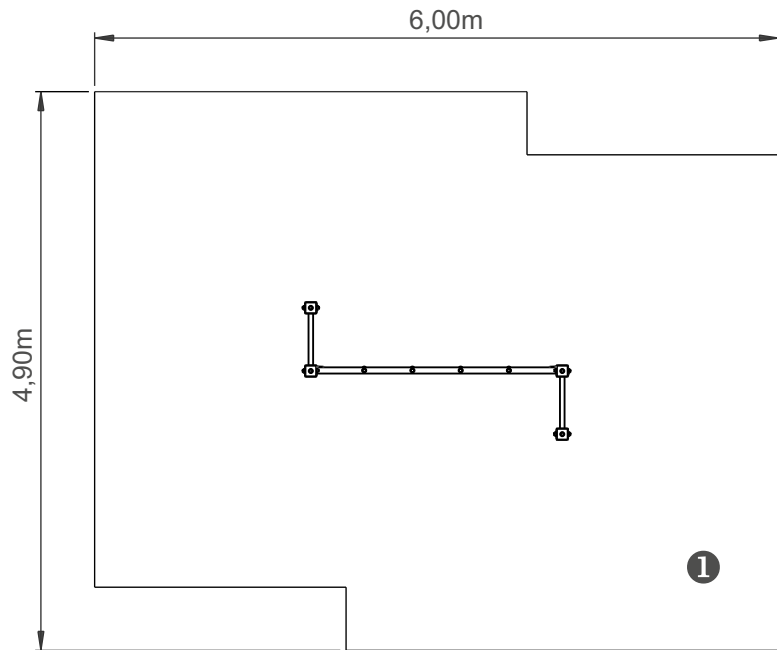

.....	①
	2,00
	27
	27

0,32m³

3h

2x

KG

KG

Technical Information:

1 - Climbing net 2.00m

2 - Lader 1.80m

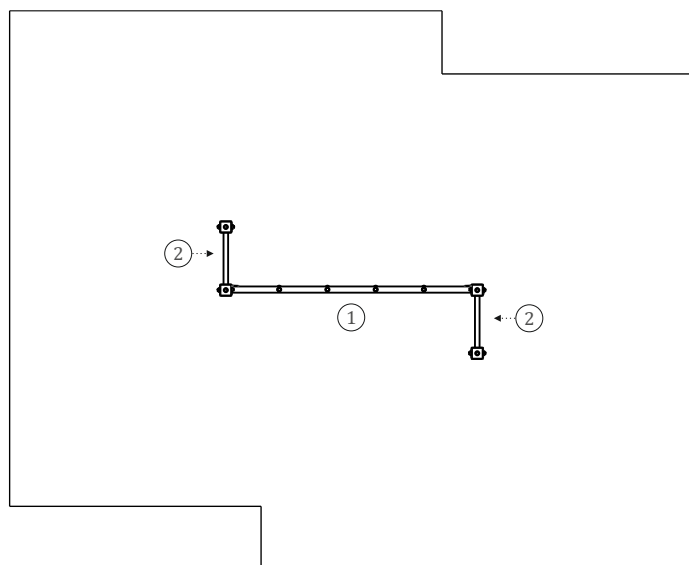









bragmaia®

Technical Characteristics:

Vertical posts

Wood: Laminated pinewood classified with guarantee of quality by continuous internal control. With autoclave treatment, protecting it from attacks of fungus, insects and termites. Finishing on aqueous base ink, specially developed to protect the wood from humidity, weather and U.V.

 **PROTECT DECORATES:**

					
<small>Penetrates into the wood grain highlighting and beautifying the wood with its transparent special colors</small>	<small>Very resistant to sun. Contains micronized absorbing pigments and U.V. stabilizers</small>	<small>Microporous, lets the wood breathe and prevents the natural deformation of wood</small>	<small>Easy maintenance. No sanding or stripping is necessary for the application of the new layers</small>	<small>Giving a protective barrier against fungus and mold</small>	<small>Protects against moisture, rain and waterproofs</small>

Panels

HDPE: Monocolour/bicolour high density polyethylene. It is a polymer so it is characterized by its resistance to corrosion and chemical products. By its capacity of elasticity and lightweight, it offers high resistance to impacts, and, therefore, very difficult to break. The non-slip surface offers security to children and the synthetic base prevents grow of bacterias and fungus. No need for maintenance;

Net: Ø16mm steel ropes coated in reinforced polypropylene fibers, connection accessories in HDPE with U.V. protection, fixing elements in galvanized hot steel;

Metal parts

Tubes:

Stainless steel: AISI 304, Ø54mm;

Fixation System: Allow its placing on the ground avoiding the wood to come into direct contact with the soil. The bottom portion of these fastening are anchored in the ground. Fabricated in galvanized steel;

Type A - Standard fixation system composed by steel base embedded in the ground with concrete;

Type B - Standard fixation system composed by steel base screwed to the ground with steel anchors;

Type C - Standard fixation system composed by posts applied directly in the ground with concrete;

Screws and accessories

Screws: Galvanized steel or optionally stainless steel AISI 304;

Capsules: PP Polypropylene plastic;



100% recyclable;

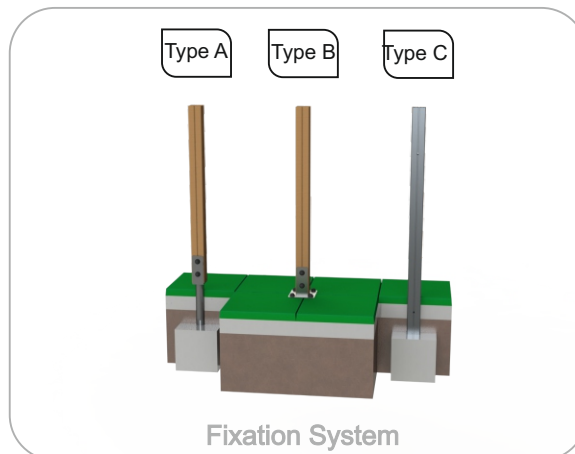

Playful Activities:



Amuse: While they have fun, children acquire several capacities, since physical abilities to social interactions.



Socialize: The socialization and imagination are necessary in all games. All of it creates a relation between children and arouses the sense of coexistence and solidarity.



Play: Develops both patience, sharing and sportsmanship.



Climbing: A movement to develop children motor skills, body control, balance and coordination, which stimulates the motor capacity an own body security.