

Trim-Trim

ref. ELDAN104



2 Usuarios

+2 AÑOS

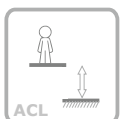

ACL

0.00 m

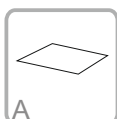

A

11 m2

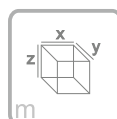

m

x= 0.36
y= 0.26
z= 1.02



Ficha Técnica

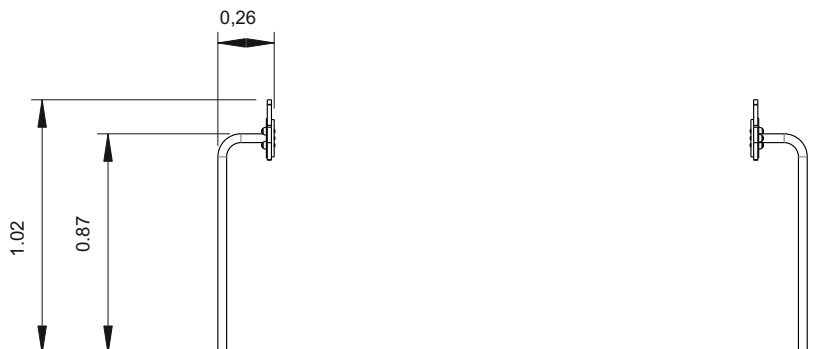
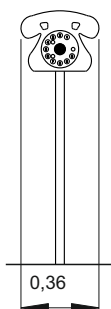





Informação do Equipamento:

— Zona de impacto

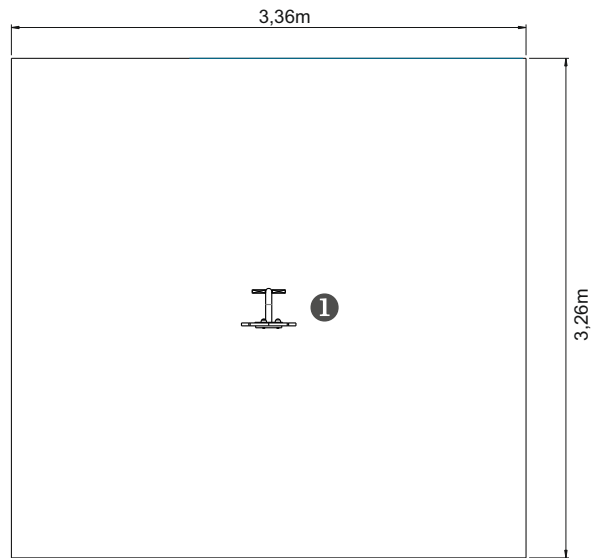
- - Espaço livre

EN 1176-1,3



.....	①
	0,00
	11
	11

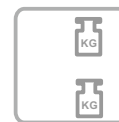
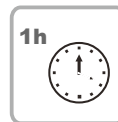
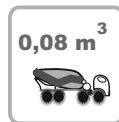

Informação Técnica:

1 - Trim-Trim

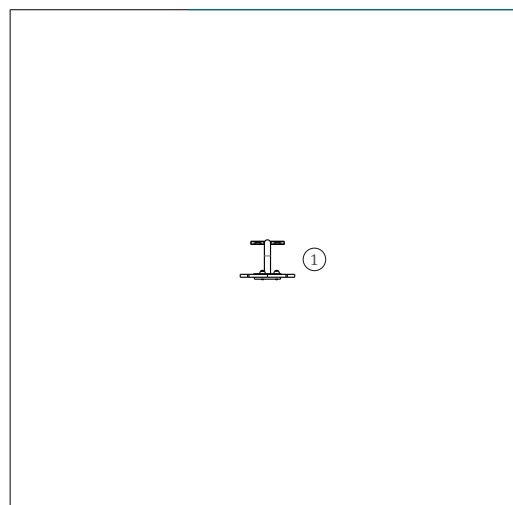

Características Técnicas:



bragmaia®

Painéis

HDPE: Polietileno de alta densidade monocolor ou bicolor. Por ser um polímero é caracterizado pela sua resistência a produtos químicos e à corrosão. Pela sua capacidade de elasticidade e leveza, oferece alta resistência ao impacto, sendo muito difícil quebrar. A superfície antiderrapante fornece segurança para as crianças e a sua base sintética impede o cultivo de bactérias e fungos. Não necessita de qualquer manutenção;

Peças Metálicas

Prumo: Aço Inox AISI 304 de Ø40mm;

Sistema de fixação:

Tipo C - Standard composto por prumo aplicado directamente no solo e chumbado com betão;

Parafusos e acessórios

Parafusos: Aço zincado ou opcionalmente aço inox AISI 304;

Cápsulas: Plástico polipropileno PP;



100% reciclável;



Funções Lúdicas:



Divertir: Enquanto se divertem, as crianças adquirem imensas capacidades, desde habilidades físicas a interações sociais.



Socializar: A socialização e a imaginação são necessárias em todo o jogo. Tudo isso cria relação entre crianças e desperta o senso de convivência e a solidariedade.



Jogar: Desenvolve a paciência, a partilha e o espírito desportivo.