

Tower

ref. ELESCT1

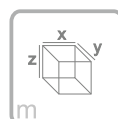

4-12 Years

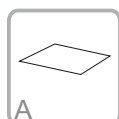
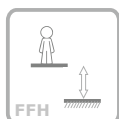

x= 0.60
y= 0.60
z= 1.00

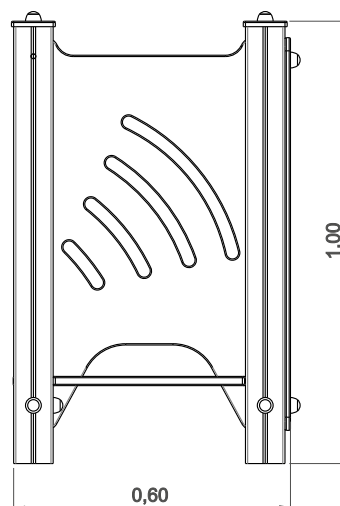
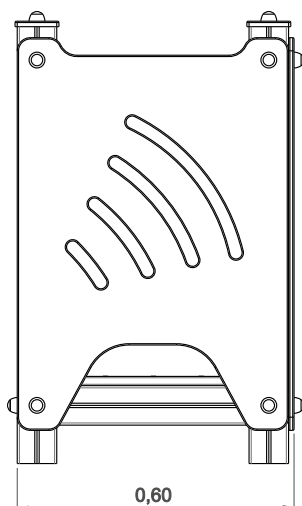

Data Sheet



Equipment Information:

— Impact area
- - Free space

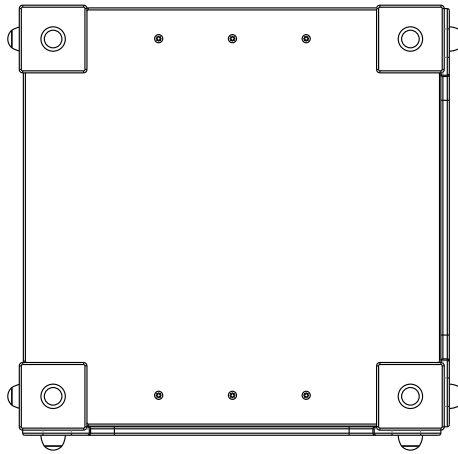
EN 1176-1,3



0,3 m³



2h



2x



KG



KG



Technical Information:

1 - Tower

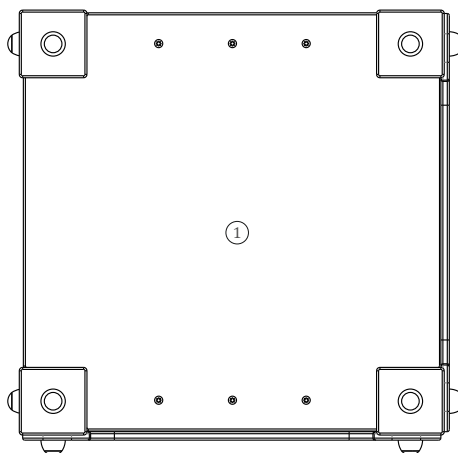









bragmaia®

Technical Characteristics:

Vertical posts

Wood: Laminated pinewood classified with guarantee of quality by continuous internal control. With autoclave treatment, protecting it from attacks of fungus, insects and termites. Finishing on aqueous base ink, specially developed to protect the wood from humidity, weather and U.V.;

 **PROTECT DECORATES:**

					
<small>Penetrates into the wood grain highlighting and beautifying the wood with its transparent special colors</small>	<small>Very resistant to sun. Contains micronized absorbing pigments and U.V. stabilizers</small>	<small>Microporous, lets the wood breathe and prevents the natural deformation of wood</small>	<small>Easy maintenance. No sanding or stripping is necessary for the application of the new layers</small>	<small>Giving a protective barrier against fungus and mold</small>	<small>Protects against moisture, rain and waterproofs</small>

Panels

HDPE: Monocolour/bicolour high density polyethylene. It is a polymer so it is characterized by its resistance to corrosion and chemical products. By its capacity of elasticity and lightweight, it offers high resistance to impacts, and, therefore, very difficult to break. The non-slip surface offers security to children and the synthetic base prevents grow of bacterias and fungus. No need for maintenance;

Marine plywood: Non-slip, bonded with phenolic resins resistant to the weather and U.V., according to EL 314-2/classe 3 (DIN 68 TS TCIL3: BFU 100, BS 6566 PART 8 : WBP);

Metal parts

Fixation System: Allow its placing on the ground avoiding the wood to come into direct contact with the soil. The bottom part of these fastening are anchored in the ground. Fabricated in galvanized steel;

Type A - Standard fixation system composed by steel base embedded in the ground with concrete;

Type B - Standard fixation system composed by steel base screwed to the ground with steel anchors;

Type C - Standard fixation system composed by posts applied directly in the ground with concrete;

Screws and accessories

Screws: Galvanized steel or optionally stainless steel AISI 304;

Capsules: PP Polypropylene plastic;



100% recyclable;

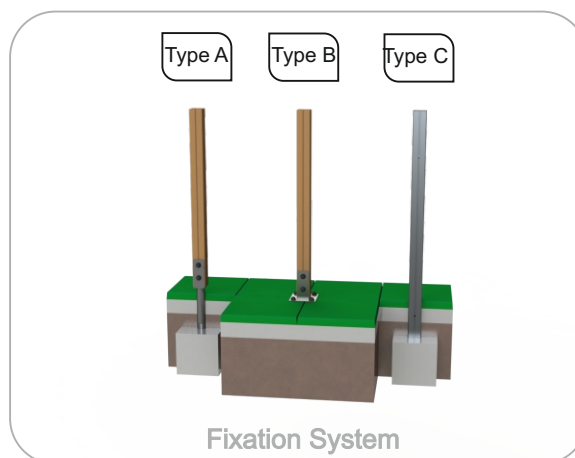

REF.	 ALTURA	 COMP.
ELESC006	2500mm	4670mm
ELESC007	3100mm	5700mm
ELESC008	3400mm	6225mm
ELESC012	4000mm	7260mm
ELESC013	4300mm	7780mm
ELESC014	5000mm	8820mm
ELESCT1	1000mm	600mm
ELESCT1 AL	1000mm	600mm
ELESCE1	2200mm	2000mm

