

Spinny

ref. ELFUC007

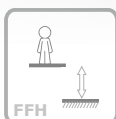

4-12 Years



1.80 m

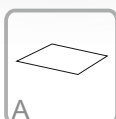

14 m²

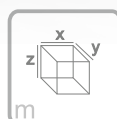

x= 0.90
y= 0.90
z= 1.80



360°

Data Sheet

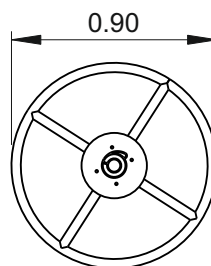
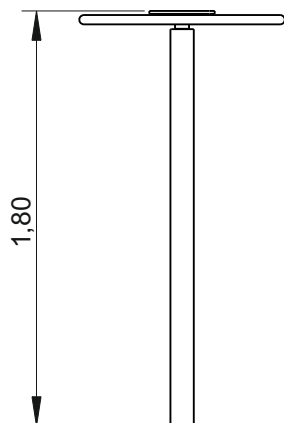



Equipment Information:

— Impact area
 - - Free space

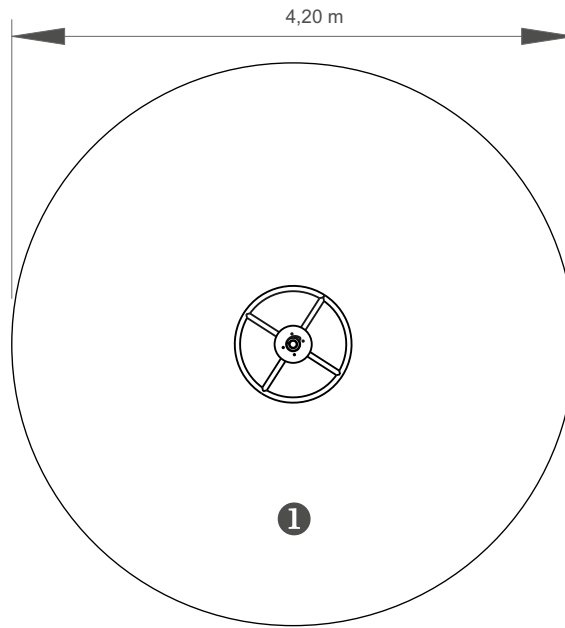
EN 1176-1,5 



.....	
	1.80
	14
	14

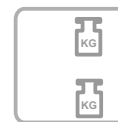
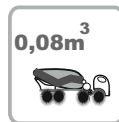

Technical Information:

1 - Carousel  1.80m

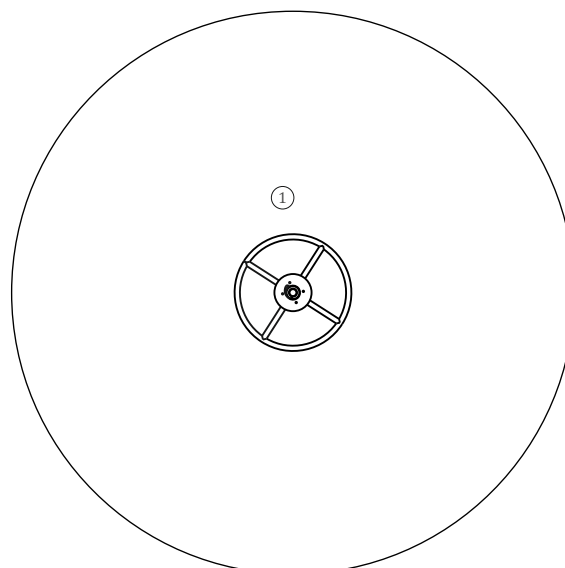



bragmaia®

Technical Characteristics:

Panels

HDPE: Monocolour/bicolour high density polyethylene. It is a polymer so it is characterized by its resistance to corrosion and chemical products. By its capacity of elasticity and lightweight, it offers high resistance to impacts, and, therefore, very difficult to break. The non-slip surface offers security to children and the synthetic base prevents grow of bacterias and fungus. No need for maintenance;

Peças Metálicas

Tubos: Aço Inox AISI de Ø40mm e de Ø100mm;

Fixation System:

Type C - Standard fixation system composed by posts applied directly in the ground with concrete;

Bearings:

Tapered - They have inner and outer tapered raceways ring and tapered rollers. They are designed to accommodate combined loads simultaneously, acting radial and axial loads. The projection lines of the raceways meet on common point on the bearing axis, to provide true rolling and low friction;

Screws and accessories

Screws: galvanized steel or optionally stainless steel AISI 304;

Capsules: PP Polypropylene plastic;



100% reciclável;

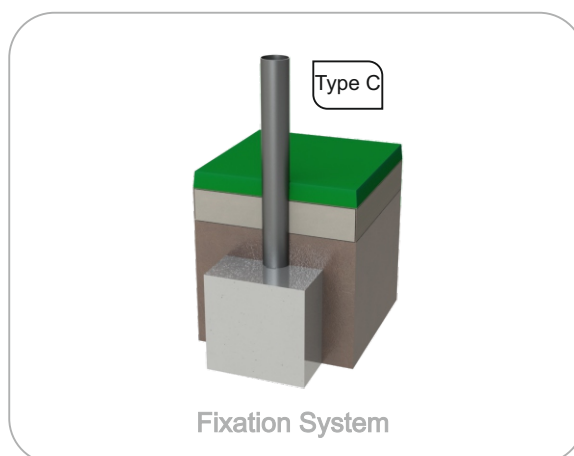

Playful Activities:



Amuse: While they have fun, children acquire several capacities, since physical abilities to social interactions.



Socialize: The socialization and imagination are necessary in all games. All of it creates a relation between children and arouses the sense of coexistence and solidarity.



Play: Develops both patience, sharing and sportsmanship.



Turning around: This activity provides a new sensation that, at the same time, improves body control, balance and coordination.