

Barbossa

ref. ELMOL046

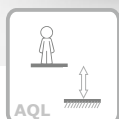

2-8 YEARS



0.45 m

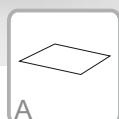

13.30 m²

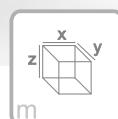

x= 0.90
y= 0.47
z= 0.79

Data Sheet

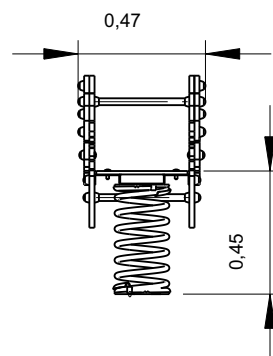
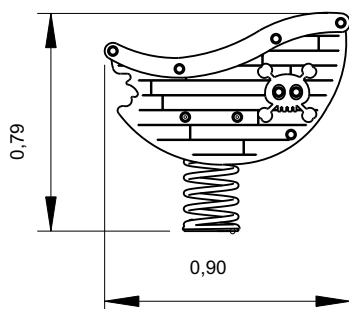



Equipment Information:

— Impact area
 - - Free space

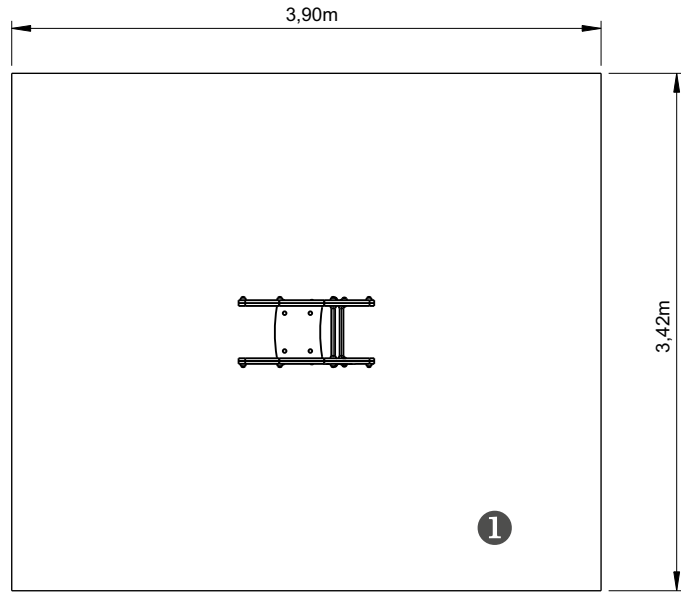
EN 1176-1,6 



.....	①
	0,45
	13.30
	13.3

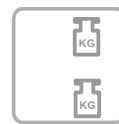
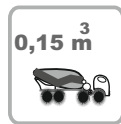

Technical Information:

1 - Spring Barbossa  0.45m

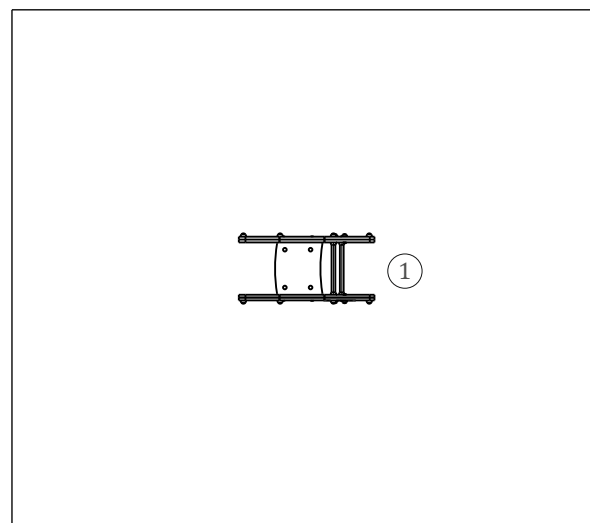



bragmaia®

Technical Characteristics:

Panels

HDPE: Monocolour/bicolour high density polyethylene. It is a polymer so it is characterized by its resistance to corrosion and chemical products. By its capacity of elasticity and lightweight, it offers high resistance to impacts, and, therefore, very difficult to break. The non-slip surface offers security to children and the synthetic base prevents grow of bacterias and fungus. No need for maintenance;

Metal Parts

Spring: Coil spring steel 35 SCD controlled on magnetoscópic field. The surface is treated with sandblasting and later with layers of preparation of zinc and two layers of polyester powder 100micros;

Tubes:

Stainless steel: AISI 304, Ø25mm;

Iron: Anticorrosive treatment of hot dip galvanizing in accordance with EN ISO 1461. Gel type lacquer at 230 ° C with thickness ranging from 50 to 70µm, according to the UNE EN ISO 2808;

Fixation System:

Type A - Standard fixation system composed by steel base embedded in the ground with concrete;

Type B - Standard fixation system composed by steel base screwed to the ground with steel anchors;

Screws and accessories

Screws: galvanized steel or optionally stainless steel AISI 304;

Capsules: PP Polypropylene plastic;



100% recyclable;

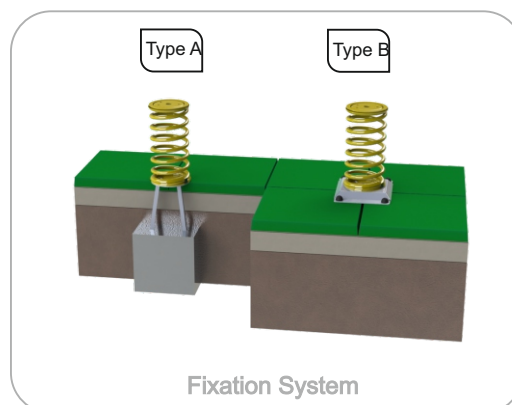

Playful Activities:



Amuse: While they have fun, children acquire several capacities, since physical abilities to social interactions.



Socialize: The socialization and imagination are necessary in all games. All of it creates a relation between children and arouses the sense of coexistence and solidarity.



Play: Develops both patience, sharing and sportsmanship.



Rocking: This action helps to develop the child balance and teaches him how to control the movements with the right balance and strength, which improves psychomotor activity and body coordination.