

Arienne

ref. ELUNI026

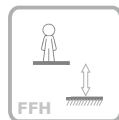

8-14 Years



2.95 m

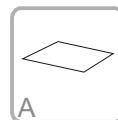

121 m²

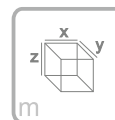

x= 16.50
y= 8.00
z= 3.40

Data Sheet

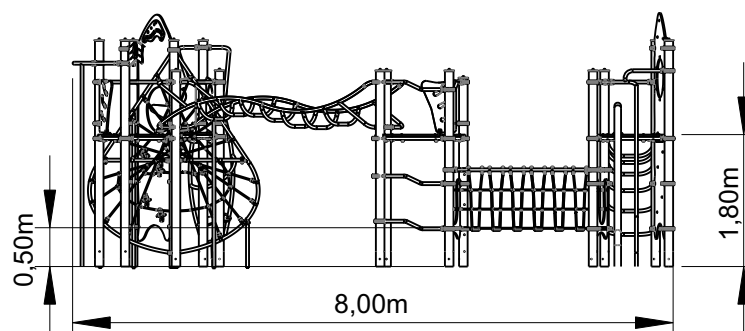
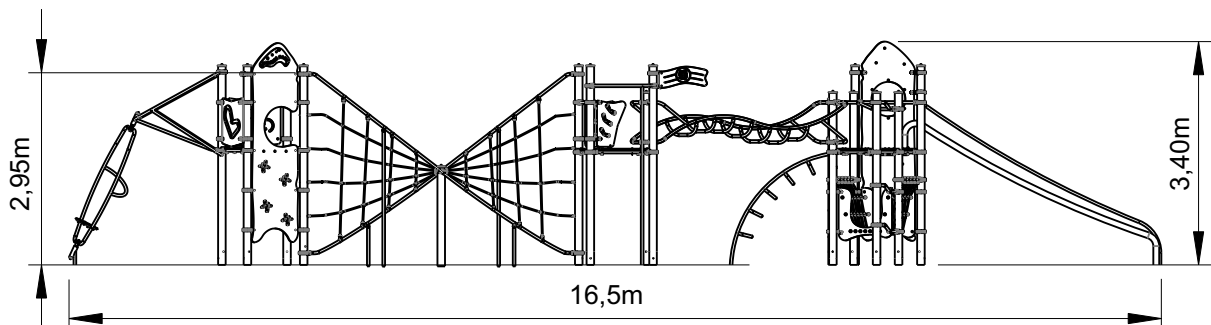



Equipment Information:

— Impact area
 - - Free space

EN 1176-1,3



| | 1 | 2 |
|---|------|------|
|  | 1.80 | 2.95 |
|  | 92 | 29 |
| | 121 | |

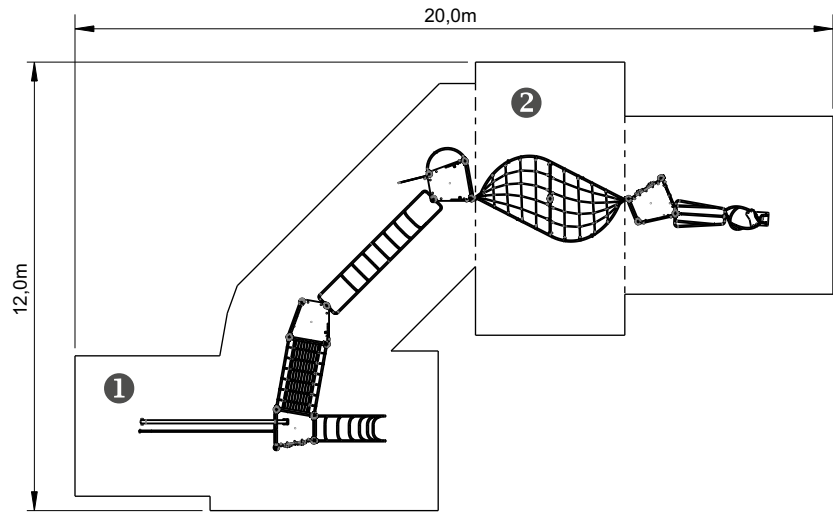

2,0 m³



24h



2x













KG



KG



Technical Information:

- 1 - Luna tower  1.80m
- 2 - Space tower  1.80m
- 3 - Ariane ladder  1.80m
- 4 - Ladder  1.80m
- 5 - Luna climbing wall  1.80m
- 6 - Space bridge  1.80m
- 7 - Turbo slide  1.80m
- 8 - Fireman rod  1.80m
- 9 - 3D Net  2.95m
- 10 - Air crossing  2.00m
- 11 - Gyro  0.50m
- 12 - Space climbing wall  1.80m

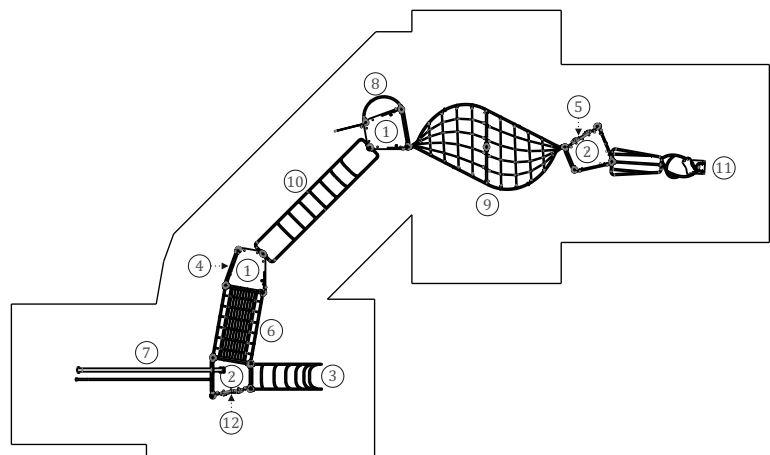

Technical Characteristics:



bragmaia®

Panels

HDPE: Monocolour/bicolour high density polyethylene. It is a polymer so it is characterized by its resistance to corrosion and chemical products. By its capacity of elasticity and lightweight, it offers high resistance to impacts, and, therefore, very difficult to break. The non-slip surface offers security to children and the synthetic base prevents grow of bacterias and fungus. No need for maintenance;

Acrylic: composed of 70% of conifers fibers and 30% thermosetting resin, weather resistant (sun, rain, humidity, etc.);

Net: Ø16mm steel ropes coated in reinforced polypropylene fibers, connection accessories in HDPE with U.V. protection, fixing elements in galvanized hot steel;

Metal parts

Tubes:

Stainless steel: AISI 304, Ø40mm and Ø114mm;

Fixation System:

Type C - Standard fixation system composed by posts applied directly in the ground with concrete;

Screws and accessories

Screws: Galvanized steel or optionally stainless steel AISI 304;

Capsules: PP Polypropylene plastic;



100% recyclable;

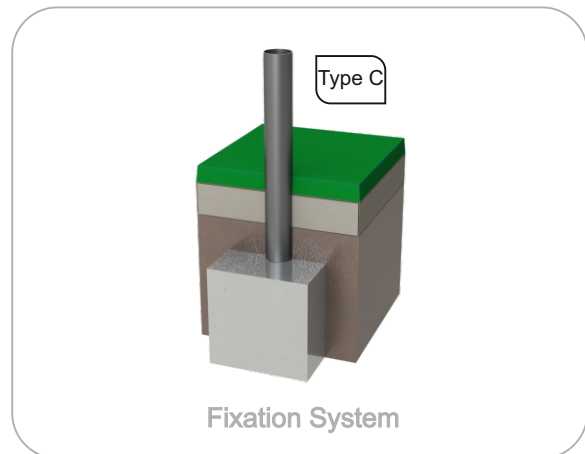



bragmaia[®]

Playful Activities:



Amuse: While they have fun, children acquire several capacities, since physical abilities to social interactions.



Socialize: The socialization and imagination are necessary in all games. All of it creates a relation between children and arouses the sense of coexistence and solidarity.



Play: Develops both patience, sharing and sportsmanship.



Climbing: A movement to develop children motor skills, body control, balance and coordination, which stimulates the motor capacity an own body security.



Glide: This activity provides a fascinating feeling which helps to develop balance and coordination by stimulating the nervous system.