

Nature Fence

ref. MURVN750

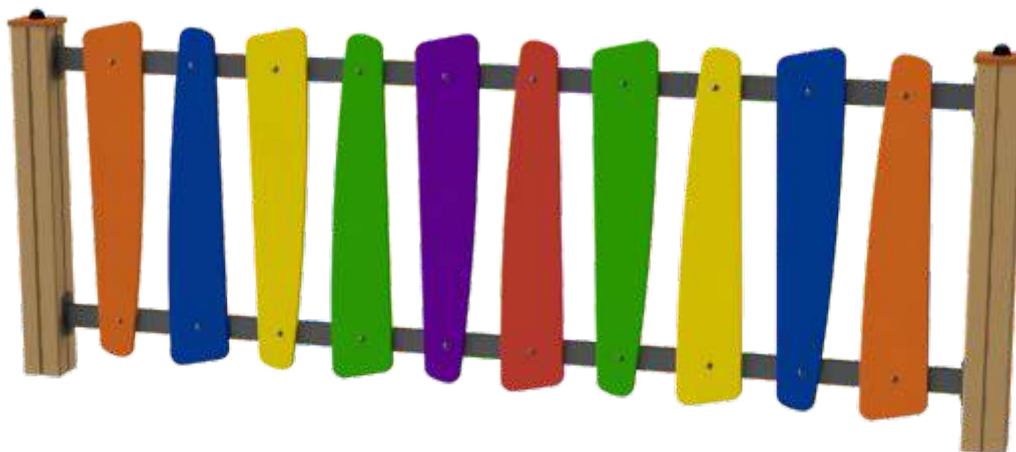

www.bragmaia.com



Total measures:

Model	Length (mm) (C)	Width (mm) (L)	Lance height (mm) (A1)	Height (mm) (A)	Total height (mm) (A1)	Type
VN750	2000	60	750	-	-	Lance
VN1000	1000	60	750	-	-	Lance
PVN750	1000	60	750	-	-	Door
VS7504A	90	90	-	800	1100	Post

General Tolerance: $\pm 5\%$

Data Sheet

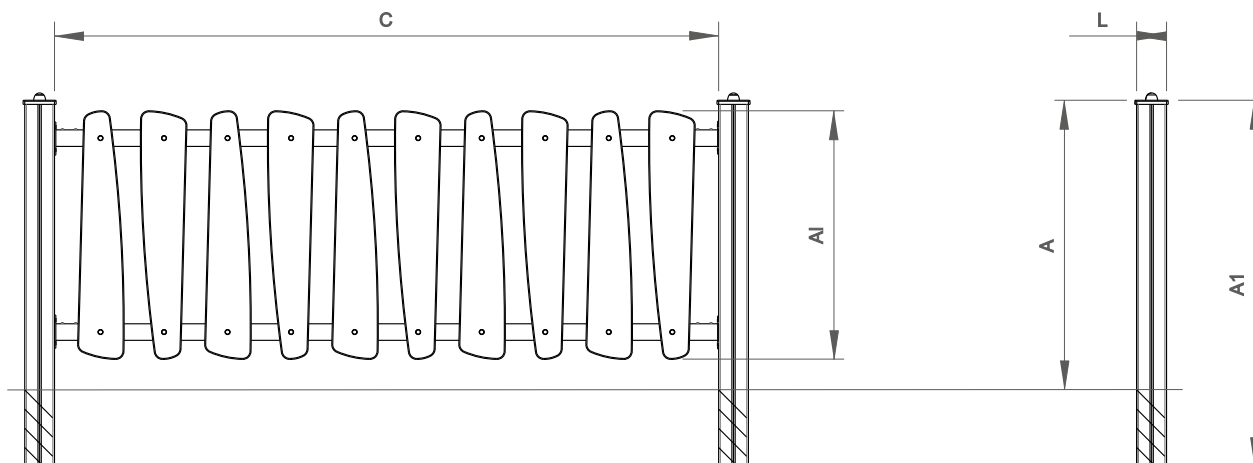

Equipment Information:

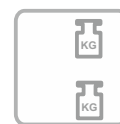
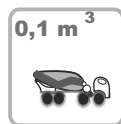
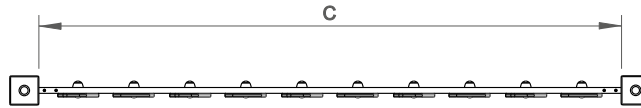

Technical Information:

1 - Nature Fence

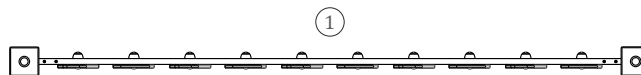







Technical Characteristics:



Vertical posts

Wood: Laminated pinewood classified with guarantee of quality by continuous internal control. With autoclave treatment, protecting it from attacks of fungus, insects and termites. Finishing on aqueous base ink, specially developed to protect the wood from humidity, weather and U.V.

 **PROTECT DECORATES:**

 <small>Penetrates into the wood grain highlighting and beautifying the wood with its transparent special colors</small>	 <small>Very resistant to sun. Contains micronized absorbing pigments and U.V. stabilizers</small>	 <small>Microporous, lets the wood breathe and prevents the natural deformation of wood</small>	 <small>Easy maintenance. No sanding or stripping is necessary for the application of the new layers</small>	 <small>Giving a protective barrier against fungus and mold</small>	 <small>Protects against moisture, rain and waterproofs</small>
--	--	---	---	---	---

Panels

HDPE: Monocolour/bicolour high density polyethylene. It is a polymer so it is characterized by its resistance to corrosion and chemical products. By its capacity of elasticity and lightweight, it offers high resistance to impacts, and, therefore, very difficult to break. The synthetic base prevents growth of bacteria and fungus. No need for maintenance;

Metal Parts

Structure: Rectangular pipe and sheet steel with anticorrosive treatment of hot dip galvanizing in accordance with EN ISO 1461;

Fixation System:

Type B - Standard fixation system composed by steel base screwed to the ground with steel anchors;

Type C - Standard fixation system composed by posts applied directly in the ground with concrete;

Screws and accessories

Screws: Galvanized steel or optionally stainless steel AISI 304;

Capsules: PP Polypropylene plastic;



100% recyclable;

