

PCM101800

Multi deck play tower, wood posts, plastic slide



With its many different activities this play tower offers high play value and supports children's development in all major areas. The inclined climbing wall and the climbing net will acquire balance and cross body coordination. The lower platform has two panels: the port window and the flower panel. From the high platform the slide can be used for a quick exit. At ground level, children can also play under the structure with the shop counter, and a bench offers a setting for social interactions.

Product Line	Multi play structures
Category	MOMENTS™ MINI Toddler & Preschool
Age group	2 - 6
Max. fall height (CM)	118
Total height (CM)	301
Safety Zone	25.7 m2



IN-
GROU.

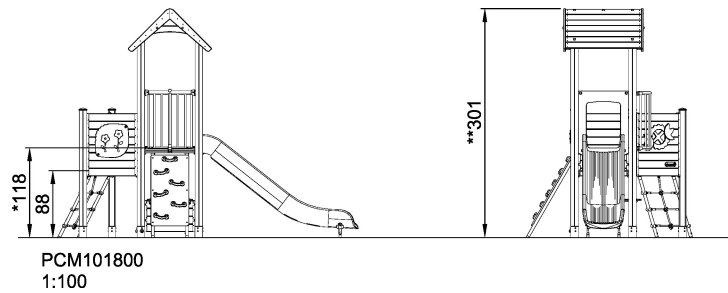
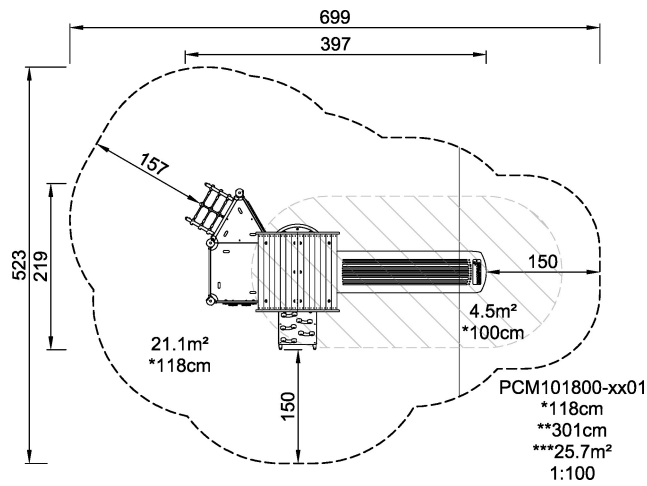

* = Highest designated play surface.
** = Total height of product.

Weight/heaviest parts	kg.	Installation (Manpower)	Persons
Concrete required	NaN m ³	Installation (Hours)	Hours
Foundation amount/footing	NaN	Excavation	NaN m ³