

Pirâmide Tridimensional

ref. PT2000

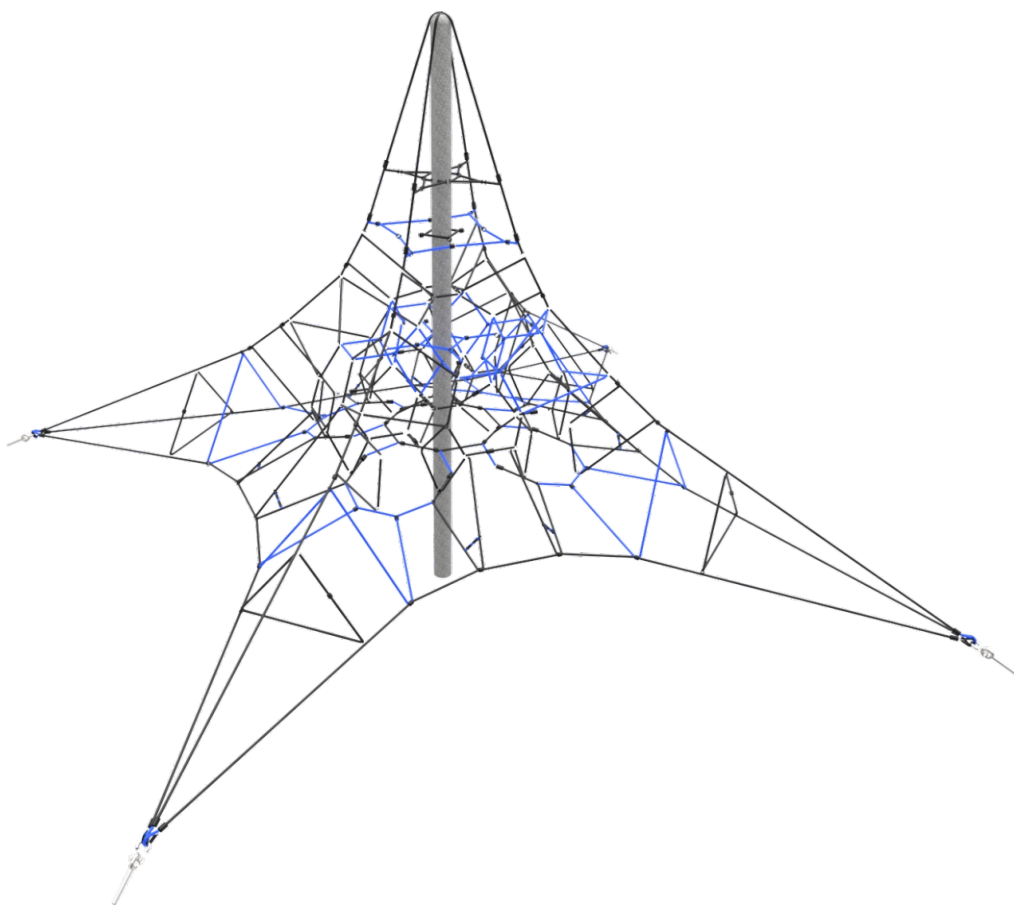

+2 ANOS

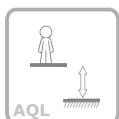

2.00 m

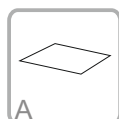

48 m²

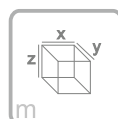

**x= 2.70
y= 2.70
z= 2.00**

Ficha Técnica

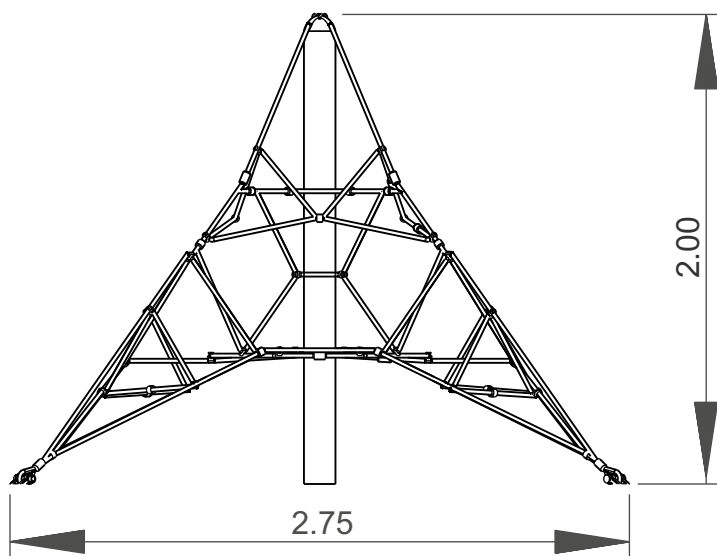



Informação do Equipamento:

— Zona de impacto

- - Espaço livre

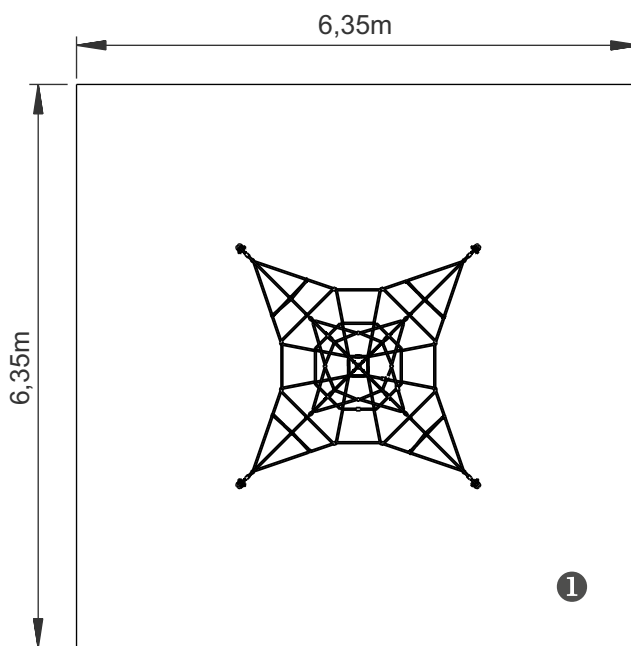
EN 1176-1

.....	①
	2.00
	48
m ²	48

1,60m³



24h



2x



KG



KG



Informação Técnica:

1 - Pirâmide Tridimensional  2.00m

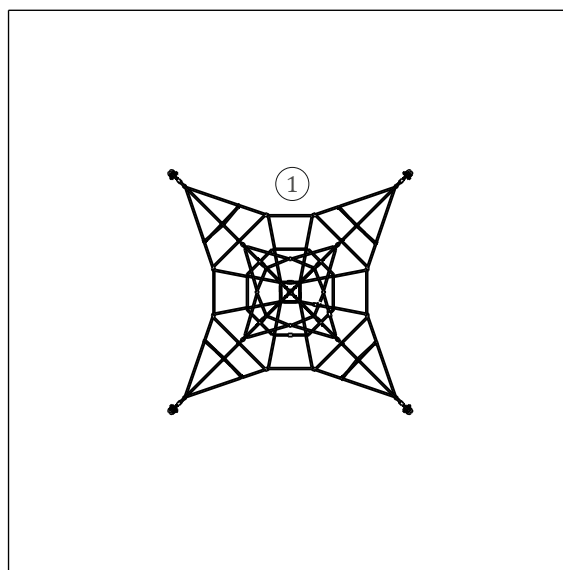

Características Técnicas:

Rede: cordas Ø16mm reforçadas em aço revestido por fibras de polipropileno, acessórios de ligação e fixação em plástico HDPE com protecção U.V., elementos de fixação em aço galvanizado a quente;

Peças Metálicas

Mastro: Aço Inox AISI 304;

Sistema de fixação:

Tipo C - Sistema de fixação standard composto por prumo aplicado directamente no solo e chumbado com betão;

Parafusos e acessórios

Parafusos: Aço zincado ou opcionalmente aço inox AISI 304;

Cápsulas: Plástico polipropileno PP;



100% reciclável;



Funções Lúdicas:



Divertir: Enquanto se divertem, as crianças adquirem imensas capacidades, desde habilidades físicas a interações sociais.



Socializar: A socialização e a imaginação são necessárias em todo o jogo. Tudo isso cria relação entre crianças e desperta o senso de convivência e a solidariedade.



Jogar: Desenvolve a paciência, a partilha e o espírito desportivo.



Trepar: Desenvolve as capacidades motrizes das crianças, o controlo do próprio corpo, o equilíbrio e a coordenação, estimulando a capacidade motora e a força nos movimentos.