

Abdominal Crunch

ref. SW006AL

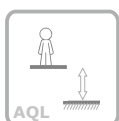

+12 Years



1.00 m

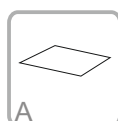

18 m²

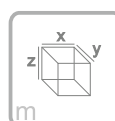

x= 1.50
y= 0.92
z= 1.32

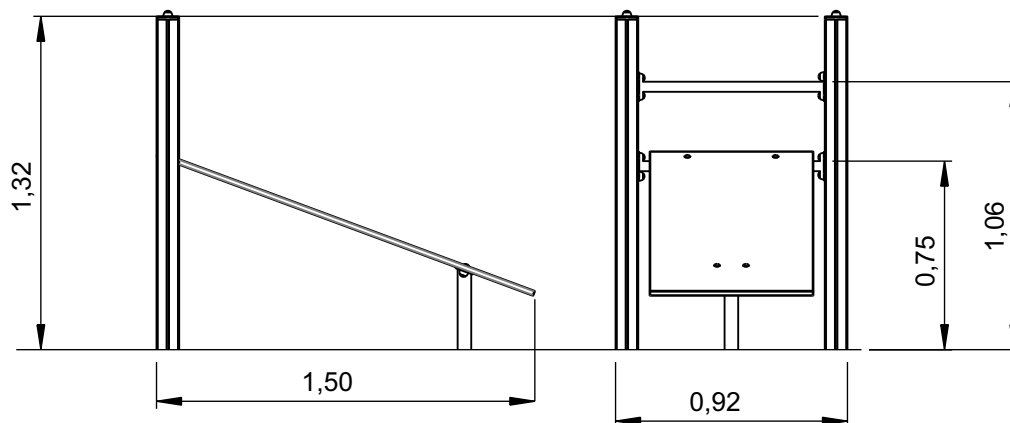



Data Sheet

Equipment Information:

— Impact area
 - - Free space

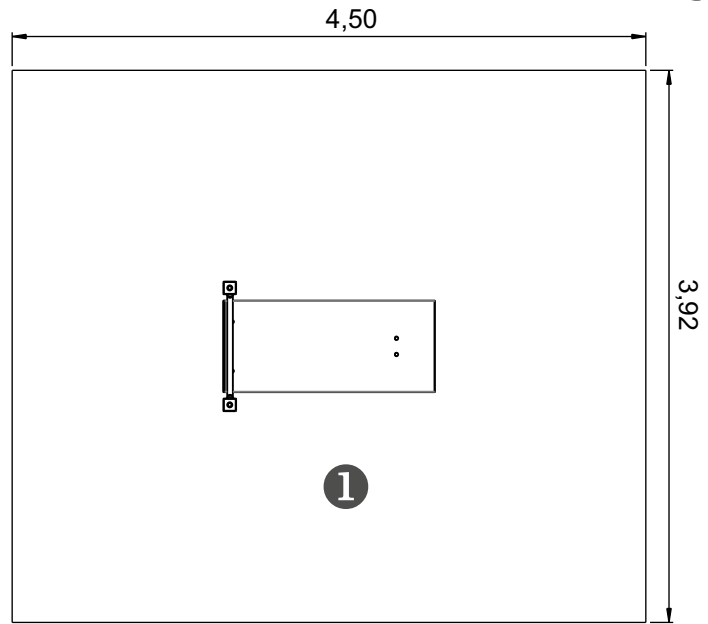
EN 1176-1





.....	①
	1,00
	18
	18

0.6 m³



8h



2x



KG



KG



Technical Information:

1 - Abdominal Crunch  2.40m

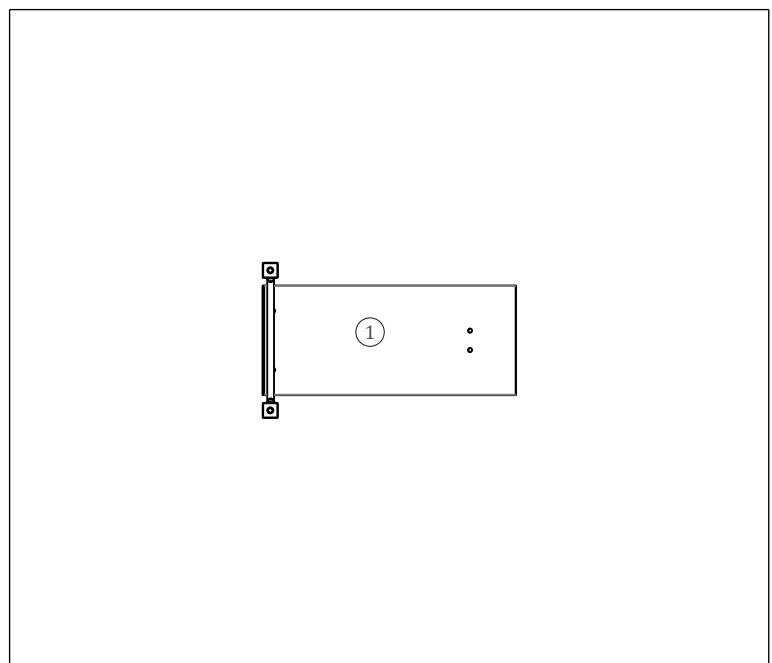

Technical Characteristics:



bragmaia[®]

Structure

Aluminum: 90x90x2.5mm profile alloy 6063 and T66 treatment, which is an alloy extrusion excellence, exhibits excellent corrosion resistance with good surface finish. The T66 treatment in which this alloy is solubilized, tempered and artificially aged, aims to improve its mechanical properties. This is supplied at natural color with the option of being lacquered RAL according to customer needs;

Panels

HDPE: Monocolour/bicolour high density polyethylene. It is a polymer so it is characterized by its resistance to corrosion and chemical products. By its capacity of elasticity and lightweight, it offers high resistance to impacts, and, therefore, very difficult to break. The synthetic base prevents grow of bacterias and fungus. No need for maintenance;

Metal parts

Tubes:

Stainless steel: AISI 304, Ø40mm;

Fixation System:

Type C - Standard fixation system composed by posts applied directly in the ground with concrete;

Screws and accessories

Screws: Galvanized steel or optionally stainless steel AISI 304;

Capsules: PP Polypropylene plastic;



100% recyclable;

