

# Trapeze

ref. SW016AL

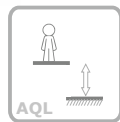

**+12 Years**



**2.50 m**

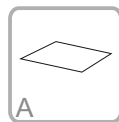

**25 m2**

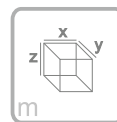



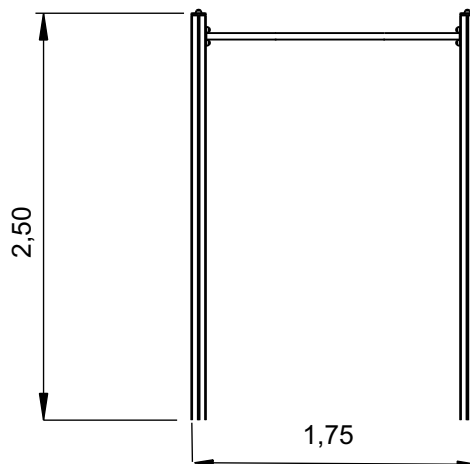

**x= 1,75  
y= 0.09  
z= 2.50**

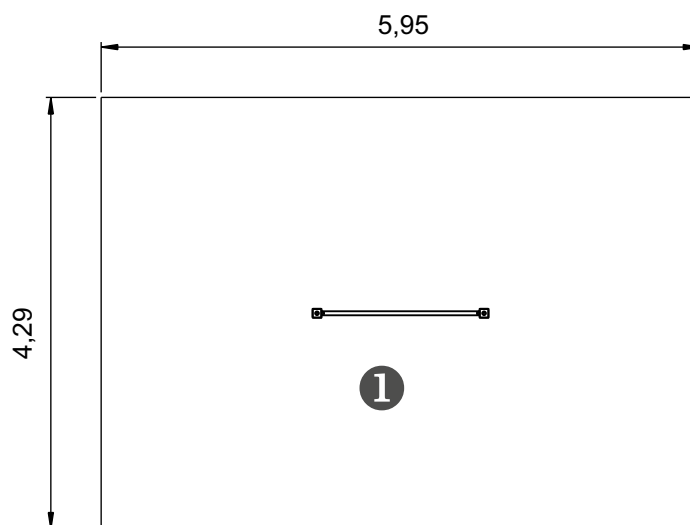
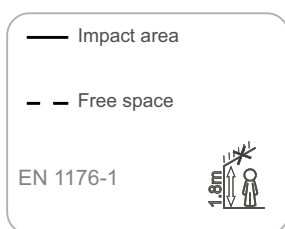

Data Sheet

# Equipment Information:



.....	①
	2,50
	25
	25

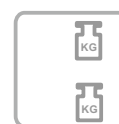
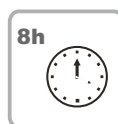
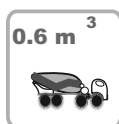

# Technical Information:

1 - Trapeze  2.50m

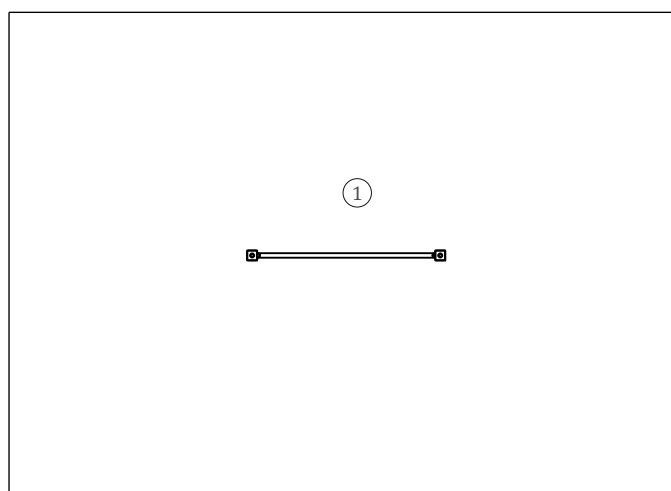

# Technical Characteristics:



**bragmaia**<sup>®</sup>

## Structure

**Aluminum:** 90x90x2.5mm profile alloy 6063 and T66 treatment, which is an alloy extrusion excellence, exhibits excellent corrosion resistance with good surface finish. The T66 treatment in which this alloy is solubilized, tempered and artificially aged, aims to improve its mechanical properties. This is supplied at natural color with the option of being lacquered RAL according to customer needs;

## Metal parts

### Tubes:

**Stainless steel:** AISI 304, Ø40mm;

### Fixation System:

**Type C - Standard fixation system** composed by posts applied directly in the ground with concrete;

### Screws and accessories

**Screws:** Galvanized steel or optionally stainless steel AISI 304;

**Capsules:** PP Polypropylene plastic;



100% recyclable;

